

THE INFORMATION CONTAINED IN THIS DRAWING IS THE SOLE PROPERTY OF L-COM, INC. ANY REPRODUCTION IN PART OR WHOLE WITHOUT THE WRITTEN PERMISSION OF L-COM, INC. IS PROHIBITED.

REVISIONS			
REV	DESCRIPTION	DATE	APPROVED
A	INITIAL RELEASE	05/25/2022	GUTTADAURO

D  
C  
B  
A

D  
C  
B  
A

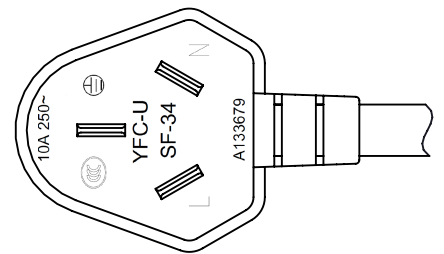
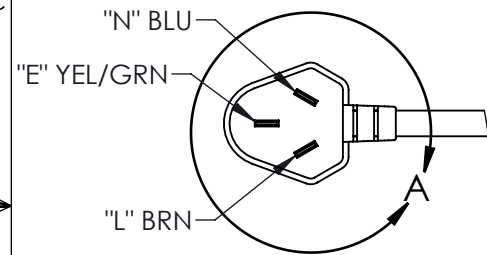
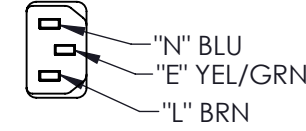
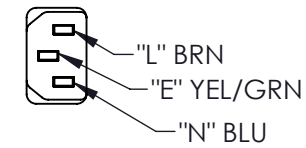
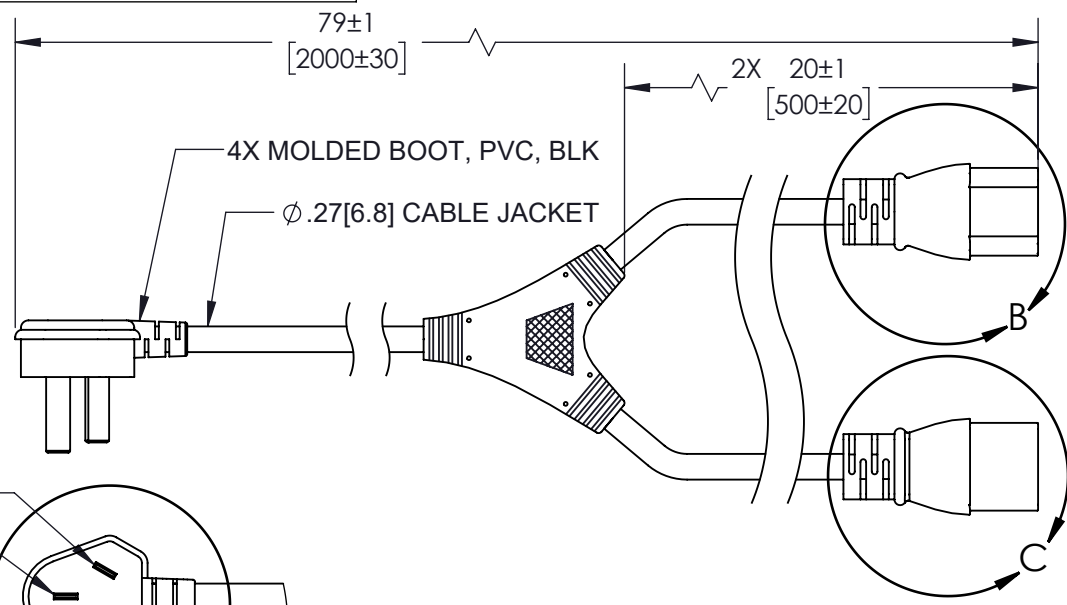

DETAIL A

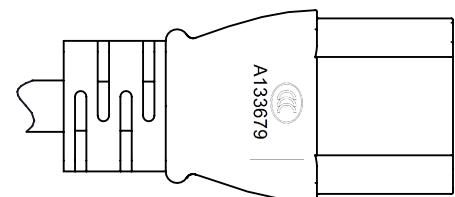

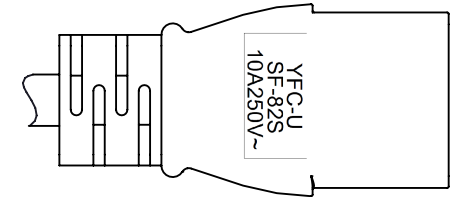

DETAIL B  
2 PLACES



DETAIL C  
2 PLACES

NOTES:

- VOLTAGE RATING:  
DIELECTRIC VOLTAGE WITHSTAND TEST: 2000V/1 SECOND  
CONDUCTOR RESISTANCE:  $\leq 22.4 \Omega / 1000$  METERS  
VOLTAGE RATING: AC 300/500V
- CABLE MARKING:  
CCC A133679 60227 IEC 53 (RVV) 300/500V 3×0.75MM<sup>2</sup>.
- OPTIONAL LABELS MAY INCLUDE UL, CURRENT AND/OR WARNING.
- CABLE ASSEMBLIES SHALL BE INDIVIDUALLY PACKAGED.
- ALL DIMENSIONS SHOWN ARE FOR REFERENCE ONLY.

UNLESS OTHERWISE SPECIFIED, DIMENSIONS ARE IN INCHES [mm] OVERALL CABLE LENGTH TOLERANCE: $\leq 12$ [305] = +1 [25] / -0 $> 12$ [305] $\leq 60$ [1524] = +2 [51] / -0 $> 60$ [1524] $\leq 120$ [3048] = +4 [102] / -0 $> 120$ [3048] $\leq 300$ [7620] = +6 [152] / -0 $> 300$ [7620] = +5% / -0 ALL OTHER DIMENSIONAL TOLERANCES: .X = $\pm .2$ [5]   FRACTIONS $\pm 1/32$ .XX = $\pm .02$ [.5]   ANGLES $\pm 1^\circ$ .XXX = $\pm .005$ [.13]	APPROVALS DRAWN BY AKRESOWSK CHECKED BY DGUST APPROVED BY GUTTADAURO	DATE 04/25/2022 04/25/2022 04/25/2022	 an INFINITO brand CATEGORY <b>POWER PRODUCTS</b>	50 High Street, West Mill, North Andover, MA 01845 USA. Phone: 1.800.341.5266 1.978.682.6936		
	THIRD-ANGLE PROJECTION 	CONFIGURATION DETAILS OF UNDIMENSIONED FEATURES MAY VARY  COLOR VARIATIONS MAY OCCUR			PRODUCT DESCRIPTION <b>CABLE ASSY, INTL PWR, TYPE I RT-ANG TO 2XC13, 10A, 2M</b>	SIZE <b>A</b> SCALE: NONE