

6

5

4

3

2

1

REVISION

ZONE	REV	DESCRIPTION	DATE	CHANGED BY	APPROVED
	A	INITIAL RELEASE	12/06/2024	HBAKKE	NOTTINGHAM

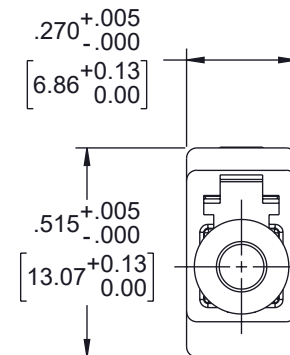
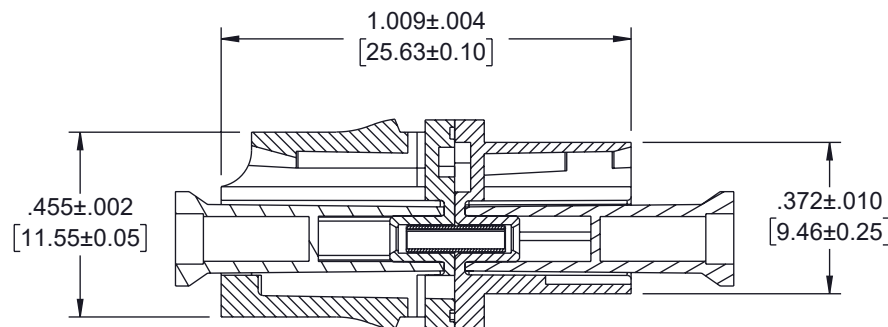
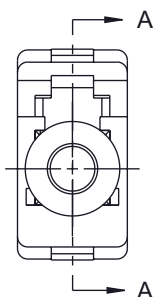
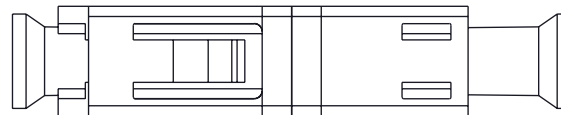

SECTION A-A

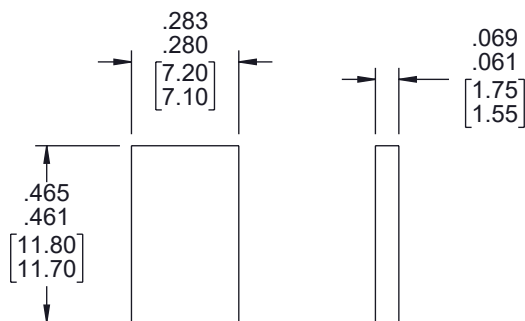
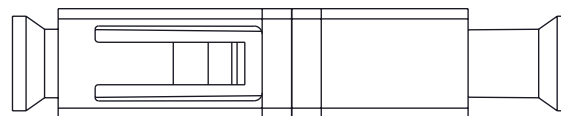

RECOMMENDED
PANEL CUTOUT

PANEL
THICKNESS

ITEM NUMBER	HOUSING COLOR
FOA-500A	BLUE SM PC
FOA-500A-GRN	GREEN SM APC
FOA-500A-BGE	BEIGE OM1 OR OM2
FOA-500A-BLK	BLACK MULTIMODE
FOA-500A-AQU	AQUA OM3
FOA-500A-HVI	HEATHER VIOLET OM4
FOA-500A-LGR	LIME GREEN OM5

NOTES:

- PARTS SHALL BE INDIVIDUALLY PACKAGED AND LABELED.

THE INFORMATION CONTAINED IN THIS DRAWING IS THE SOLE PROPERTY OF INFINITE ELECTRONICS, INC. ANY REPRODUCTION IN PART OR WHOLE WITHOUT THE WRITTEN PERMISSION OF INFINITE ELECTRONICS, INC. IS PROHIBITED. THESE COMMODITIES, TECHNOLOGY OR SOFTWARE WERE EXPORTED FROM THE UNITED STATES IN ACCORDANCE WITH THE EXPORT ADMINISTRATION REGULATIONS. DIVERSION CONTRARY TO U.S. LAW PROHIBITED.

UNLESS OTHERWISE SPECIFIED
LEADING DIMENSIONS ARE INCHES
DIMENSIONS IN [] ARE MILLIMETERS

TOLERANCES:
 X = ±.2 [5] FRACTIONS
 XX = ±.02 [0.5] ± 1/32
 XXX = ±.005 [0.13] ANGLES ± 1°

CABLE LENGTH TOLERANCES:
 ≤12 [305] = +1 [25] / -0
 >12 [305] ≤ 60 [1524] = +2 [51] / -0
 >60 [1524] ≤ 120 [3048] = +4 [102] / -0
 >120 [3048] ≤ 300 [7620] = +6 [152] / -0
 >300 [7620] = +5% / -0

ALL DIMENSIONS ARE FOR REFERENCE ONLY
AND SUBJECT TO CHANGE WITHOUT NOTICE.
UN-DIMENSIONED NON-CRITICAL FEATURES
MAY VARY IN SIZE AND LOCATION
COLORS MAY VARY

L-com
an INFINIT® brand

Website: www.L-com.com
Phone: 1.800.341.5266 | 1.978.682.6936

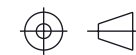

INTERPRET ALL DIMENSIONS AND
TOLERANCES PER ASME Y14.5

SCALE SHEET
NONE 1 OF 1

DESCRIPTION
LC SIMPLEX LOW PROFILE GREEN ADAPTER NO FLANGE ZR
SLEEVE

SIZE	CAGE CODE	DRAWN BY	ITEM NO.	REV
A	43321	HBAKKE	FOA-500A-GRN	A

6

5

4

3

2

1