

6

5

4

3

2

1

## REVISION

ZONE	REV	DESCRIPTION	DATE	CHANGED BY	APPROVED
	A	INITIAL RELEASE	12/10/2024	HBAKKE	NOTTINGHAM

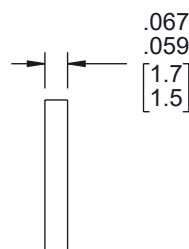
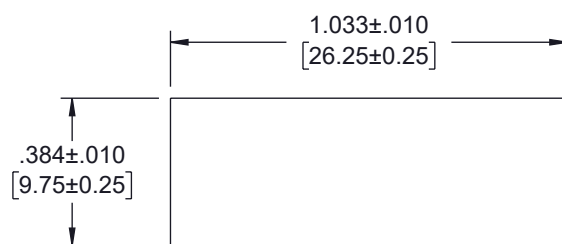
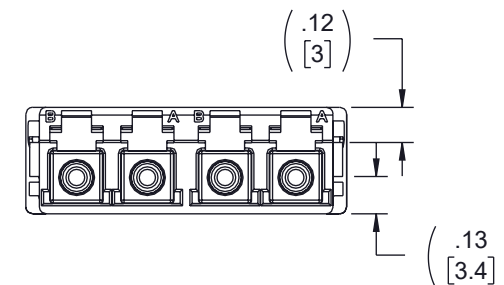
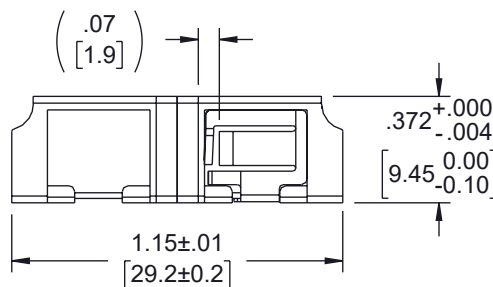
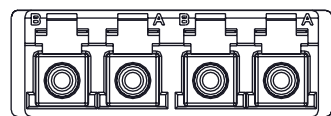
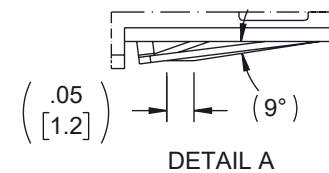
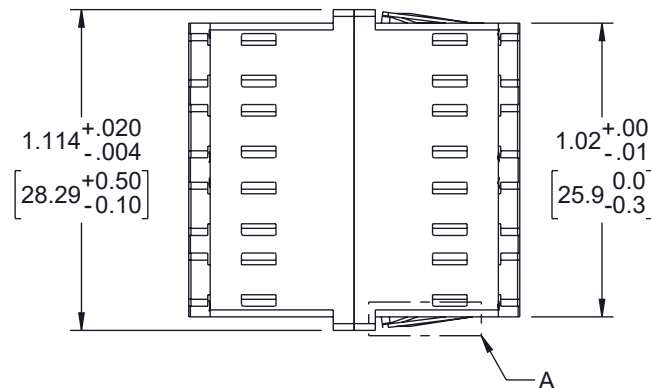
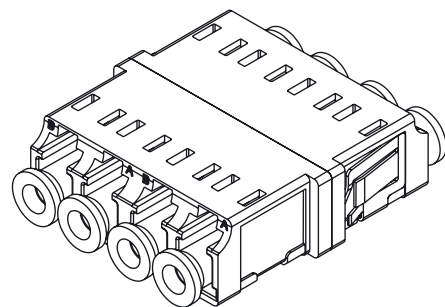
RECOMMENDED  
PANEL CUTOUTPANEL  
THICKNESS

ITEM NUMBER	HOUSING COLOR
FOA-571-BLU	BLUE SM PC
FOA-571-GRN	GREEN SM APC
FOA-571-BGE	BEIGE OM1 OR OM2
FOA-571-BLK	BLACK MULTIMODE
FOA-571-AQU	AQUA OM3
FOA-571-HVI	HEATHER VIOLET OM4
FOA-571-LGR	LIME GREEN OM5

## NOTES:

- PARTS SHALL BE INDIVIDUALLY PACKAGED AND LABELED.

THE INFORMATION CONTAINED IN THIS DRAWING IS THE SOLE PROPERTY OF INFINITE ELECTRONICS, INC. ANY REPRODUCTION IN PART OR WHOLE WITHOUT THE WRITTEN PERMISSION OF INFINITE ELECTRONICS, INC. IS PROHIBITED. THESE COMMODITIES, TECHNOLOGY OR SOFTWARE WERE EXPORTED FROM THE UNITED STATES IN ACCORDANCE WITH THE EXPORT ADMINISTRATION REGULATIONS. DIVERSION CONTRARY TO U.S. LAW PROHIBITED.

UNLESS OTHERWISE SPECIFIED  
LEADING DIMENSIONS ARE INCHES  
DIMENSIONS IN [ ] ARE MILLIMETERS

TOLERANCES:  
X = ± 2 [5] FRACTIONS  
XX = ± 0.02 [0.5] ± 1/32  
.XXX = ± 0.005 [0.13] ANGLES ± 1°

CABLE LENGTH TOLERANCES:  
≤ 12 [305] = +1 [25] / -0  
> 12 [305] ≤ 60 [1524] = +2 [51] / -0  
> 60 [1524] ≤ 120 [3048] = +4 [102] / -0  
> 120 [3048] ≤ 300 [7620] = +6 [152] / -0  
> 300 [7620] = +5% / -0

ALL DIMENSIONS ARE FOR REFERENCE ONLY  
AND SUBJECT TO CHANGE WITHOUT NOTICE.  
UN-DIMENSIONED/NON-CRITICAL FEATURES  
MAY VARY IN SIZE AND LOCATION  
COLORS MAY VARY

**L-com**  
an INFINIT® brand

Website: www.L-com.com  
Phone: 1.800.341.5266 | 1.978.682.6936

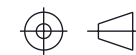

INTERPRET ALL DIMENSIONS AND  
TOLERANCES PER ASME Y14.5

SCALE	SHEET
NONE	1 OF 1

## DESCRIPTION

LC COMPACT RECEPTACLE QUAD ADAPTER W/ REDUCED  
FLANGE, ZR SLEEVE, BEIGE HOUSING W/ METAL SPRING

SIZE	CAGE CODE	DRAWN BY	ITEM NO.	REV
A	43321	HBAKKE	FOA-571-BGE	A

6

5

4

3

2

1