

THE INFORMATION CONTAINED IN THIS DRAWING IS THE SOLE PROPERTY OF L-COM, INC. ANY REPRODUCTION IN PART OR WHOLE WITHOUT THE WRITTEN PERMISSION OF L-COM, INC. IS PROHIBITED.

REVISION					
ZONE	REV	DESCRIPTION	DATE	CHANGED BY	APPROVED
	A	INITIAL RELEASE	03/06/2023	HBAKKE	PHOSPODAR

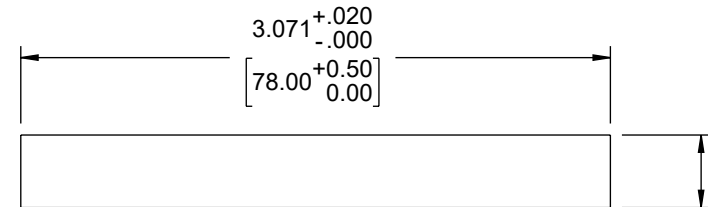
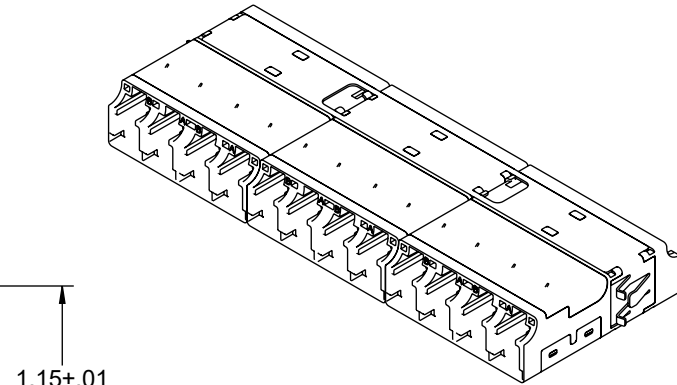
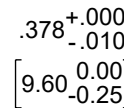
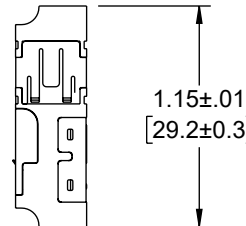
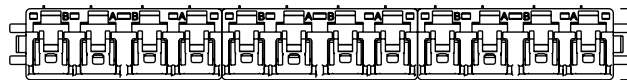
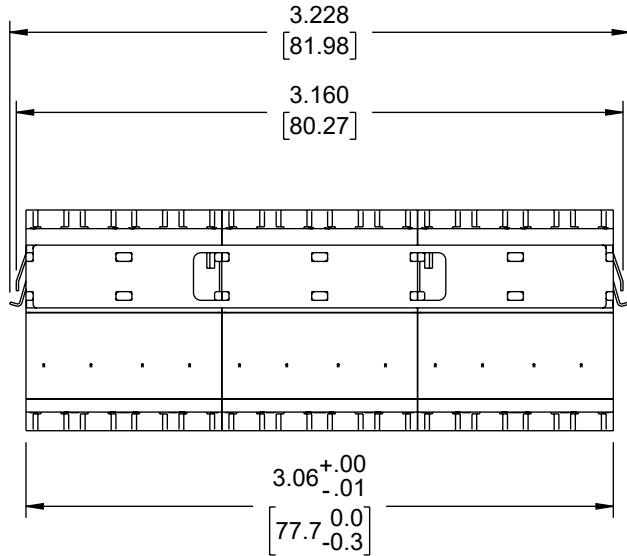
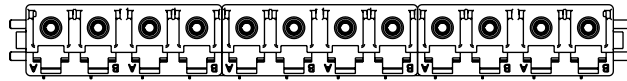

NOTES:

- ALL DIMENSIONS ARE FOR REFERENCE ONLY.
- DUST CAPS NOT SHOWN.
- RECOMMENDED PANEL THICKNESS: .05-.07" [1.2-1.7mm]
- STANDARDS: IEC 61754-20, TIA/EIA 604-10A-2002, TELCORDIA GR-326-CORE
- INSERTION LOSS: <0.2dB
- OPERATING/STORAGE TEMPERATURE: -40 TO +85°C
- COMPONENT SHALL BE INDIVIDUALLY PACKAGED IN ACCORDANCE WITH L-COM SPECIFICATION PS-0031.

REGULATORY COMPLIANCE:

EU RoHS DIRECTIVE (MOST RECENT RELEASED VERSION)

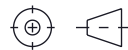
UNLESS OTHERWISE SPECIFIED, DIMENSIONS ARE IN INCHES [mm]	APPROVALS	DATE	 50 High Street, West Mill, North Andover, MA 01845 USA. Phone: 1.800.341.5266 1.978.682.6936
	DRAWN BY HBAKKE	03/06/2023	
OVERALL CABLE LENGTH TOLERANCE: ≤12 [305] = +1 [25] / -0 >12 [305] ≤60 [1524] = +2 [51] / -0 >60 [1524] ≤120 [3048] = +4 [102] / -0 >120 [3048] ≤300 [7620] = +6 [152] / -0 >300 [7620] = +5% / -0	CHECKED BY DMAY	03/06/2023	CATEGORY FIBER OPTICS
ALL OTHER DIMENSIONAL TOLERANCES: .X = ± .2 [5] FRACTIONS ± 1/32 .XX = ± .02 [5] ANGLES ± 1° .XXX = ± .005 [13]	APPROVED BY REVANGELIS	03/06/2023	
THIRD-ANGLE PROJECTION 	CONFIGURATION DETAILS OF UNDIMENSIONED FEATURES MAY VARY	PRODUCT DESCRIPTION Fiber Coupler, LC/LC SlimLine 12 port, Translucent Internal Shutter, Side Spring, High Density Reduced Height, No Flange, Green	SIZE A
	COLOR VARIATIONS MAY OCCUR	CAGE CODE 43321	ITEM NO. FOA-850-GRN
		SCALE: NONE	SHEET 1 OF 1