

6

5

4

3

2

1

REVISION					
ZONE	REV.	DESCRIPTION	DATE	CHANGED BY	APPROVED BY
	A	INITIAL RELEASE	07/18/2023	DZINN	THOUGHTON

CABLE MANAGEMENT PANEL
TOP & BOTTOM

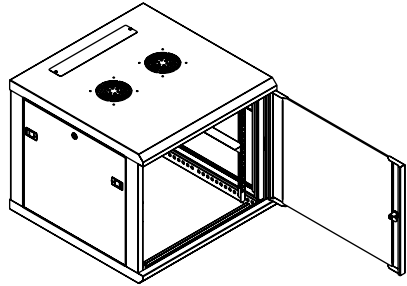

□ 4.13
[105]

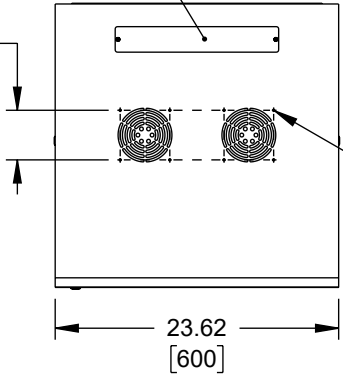

8X Ø.177 [4.50] THRU

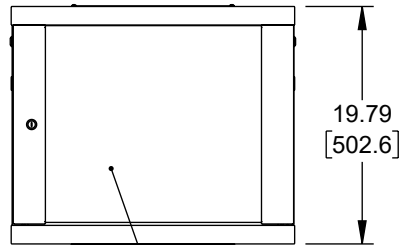
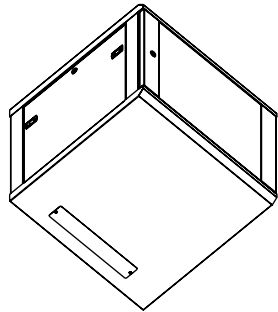
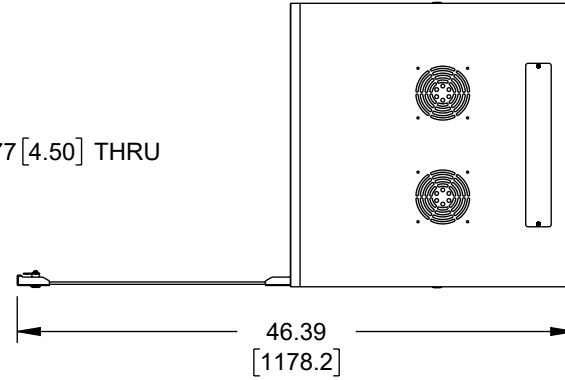

GLASS DOOR

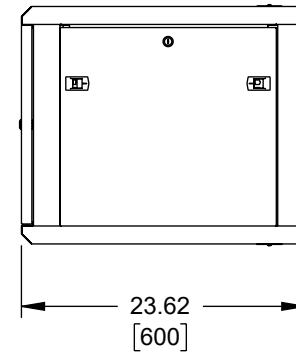

THE INFORMATION CONTAINED IN THIS DRAWING IS THE SOLE PROPERTY OF INFINITE ELECTRONICS, INC. ANY REPRODUCTION IN PART OR WHOLE WITHOUT THE WRITTEN PERMISSION OF INFINITE ELECTRONICS, INC. IS PROHIBITED. THESE COMMODITIES, TECHNOLOGY OR SOFTWARE WERE EXPORTED FROM THE UNITED STATES IN ACCORDANCE WITH THE EXPORT ADMINISTRATION REGULATIONS. DIVERSION CONTRARY TO U.S. LAW PROHIBITED.

UNLESS OTHERWISE SPECIFIED
LEADING DIMENSIONS ARE INCHES
DIMENSIONS IN [] ARE MILLIMETERS

TOLERANCES:
 X = ±.2 [5] FRACTIONS ± 1/32
 .XX = ±.02 [0.5] ANGLES ± 1°
 .XXX = ±.005 [0.13]

CABLE LENGTH TOLERANCES:
 ≤12 [305] = +1 [25] / -0
 >12 [305] ≤ 60 [1524] = +2 [51] / -0
 >60 [1524] ≤ 120 [3048] = +4 [102] / -0
 >120 [3048] ≤ 300 [7620] = +6 [152] / -0
 >300 [7620] = +5% / -0

ALL DIMENSIONS ARE FOR REFERENCE ONLY
AND SUBJECT TO CHANGE WITHOUT NOTICE.
UN-DIMENSIONED/NON-CRITICAL FEATURES
MAY VARY IN SIZE AND LOCATION
COLORS MAY VARY



an INFINITE brand
 Website: www.L-com.com
 Phone: 1.800.341.5266 | 1.978.682.6936

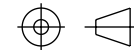

INTERPRET ALL DIMENSIONS AND
TOLERANCES PER ASME Y14.5

SCALE NONE SHEET 1 OF 1

DESCRIPTION
 19IN WALL MOUNT CABINET, 9U, 23IN [600mm] DEEP

SIZE	CAGE CODE	DRAWN BY	ITEM NO.	REV
A	43321	DZINN	LC-SMA6609-W	A

6

5

4

3

2

1