

REVISIONS			
REV.	DESCRIPTION	DATE	APPROVED
A	INITIAL RELEASE	05/23/2019	BPUCHASKI

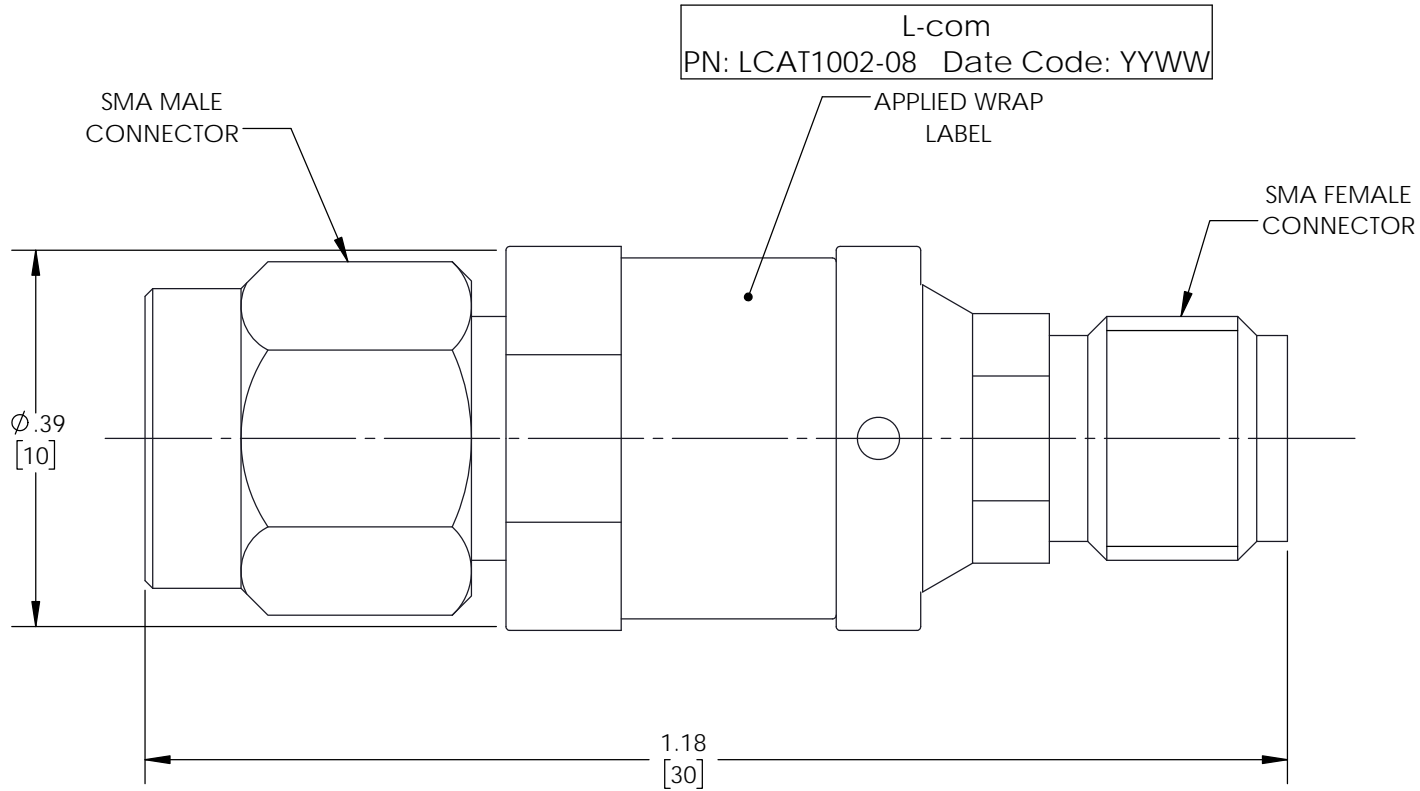
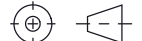

THESE COMMODITIES, TECHNOLOGY OR SOFTWARE WERE EXPORTED FROM THE UNITED STATES IN ACCORDANCE WITH THE EXPORT ADMINISTRATION REGULATIONS. DIVERSION CONTRARY TO U.S. LAW PROHIBITED.

UNLESS OTHERWISE SPECIFIED LEADING DIMENSIONS ARE INCHES DIMENSIONS IN [] ARE MILLIMETERS		 an INFINITO brand 50 High Street, West Mill, 3rd Floor, Suite #30 North Andover, MA 01845 USA. Phone: 1.800.341.5266 1.978.682.6936 Fax: 1.978.689.9484 e-mail: CustomerService@L-com.com		THE INFORMATION AND DESIGN IN THIS DOCUMENT IS THE PROPERTY OF L-COM GLOBAL CONNECTIVITY. ALL RIGHTS RESERVED.	
TOLERANCES: X=± .2 [5.08] FRACTIONS ± 1/32 .XX=± .01 [.25] ANGLES ± 1° .XXX=± .005 [.13]				SHEET 1 OF 1	
ALL DIMENSIONS SHOWN ARE FOR REFERENCE ONLY.		SCALE N/A			
THIRD-ANGLE PROJECTION 		www.L-com.com	DRAWN BY BPUCHASKI	PART NUMBER LCAT1002-08	REV A
SIZE A	CAGE 43321				