

6

5

4

3

2

1

REVISION

ZONE	REV	DESCRIPTION	DATE	CHANGED BY	APPROVED
	A	INITIAL RELEASE	01/22/2024	HBAKKE	SPONG

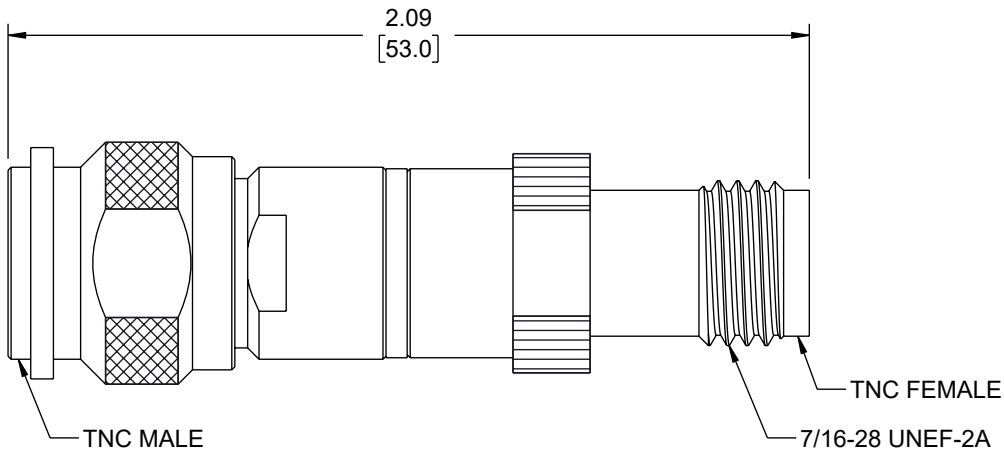
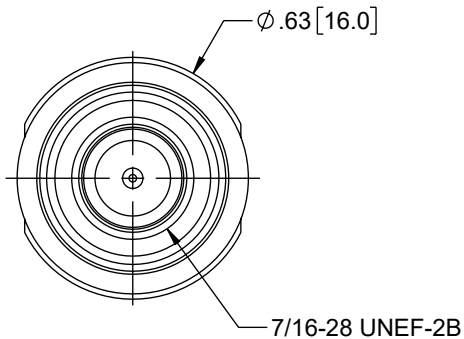

UNLESS OTHERWISE SPECIFIED  
LEADING DIMENSIONS ARE INCHES  
DIMENSIONS IN [ ] ARE MILLIMETERS

TOLERANCES:  
X = ±.2 [5]      FRACTIONS ± 1/32  
.XX = ±.02 [0.5]      ANGLES ± 1°  
.XXX = ±.005 [0.13]

CABLE LENGTH TOLERANCES:  
≤12 [305] = +1 [25] / -0  
>12 [305] ≤ 60 [1524] = +2 [51] / -0  
>60 [1524] ≤ 120 [3048] = +4 [102] / -0  
>120 [3048] ≤ 300 [7620] = +6 [152] / -0  
>300 [7620] = +5% / -0

ALL DIMENSIONS ARE FOR REFERENCE ONLY  
AND SUBJECT TO CHANGE WITHOUT NOTICE  
UN-DIMENSIONED/NON-CRITICAL FEATURES  
MAY VARY IN SIZE AND LOCATION  
COLORS MAY VARY



Website: [www.L-com.com](http://www.L-com.com)  
Phone: 1.800.341.5266 | 1.978.682.6936

INTERPRET ALL DIMENSIONS AND TOLERANCES PER ASME Y14.5

SCALE	SHEET
NONE	1 OF 1

DESCRIPTION  
**30 dB 50 OHM FIXED ATTENUATOR TNC MALE TO TNC FEMALE  
3 GHz RATED 2 WATT**

THE INFORMATION CONTAINED IN THIS DRAWING IS THE SOLE PROPERTY OF INFINITE ELECTRONICS, INC. ANY REPRODUCTION IN PART OR WHOLE WITHOUT THE WRITTEN PERMISSION OF INFINITE ELECTRONICS, INC. IS PROHIBITED. THESE COMMODITIES, TECHNOLOGY OR SOFTWARE WERE EXPORTED FROM THE UNITED STATES IN ACCORDANCE WITH THE EXPORT ADMINISTRATION REGULATIONS. DIVERSION CONTRARY TO U.S. LAW PROHIBITED.

SIZE	CAGE CODE	DRAWN BY	ITEM NO.	REV
A	43321	HBAKKE	LCAT7609-30	A

6

5

4

3

2

1