

6

5

4

3

2

1

REVISION					
ZONE	REV	DESCRIPTION	DATE	CHANGED BY	APPROVED
	A	INITIAL RELEASE	12/14/2023	AKRESOWSKI	GUTTADAURO

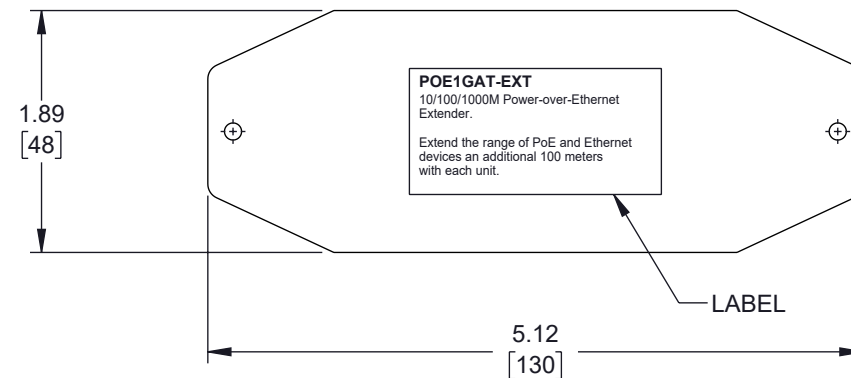
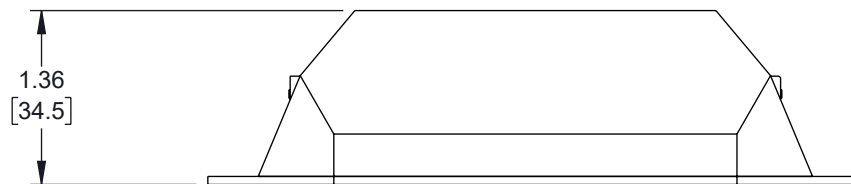
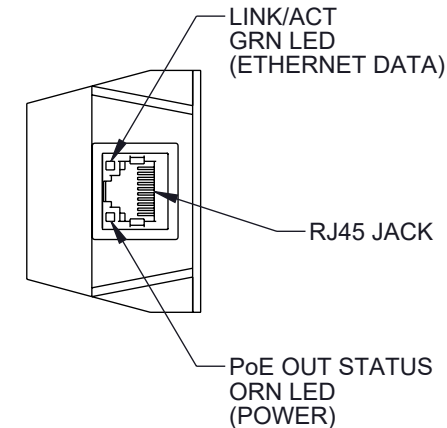
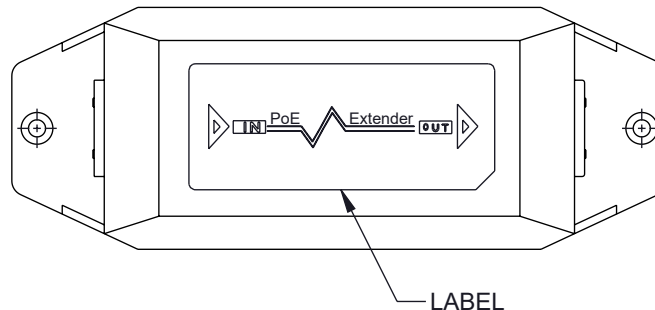
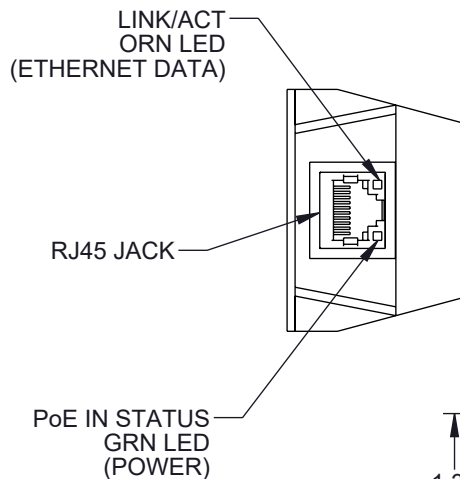

POE1GAT-EXT
 10/100/1000M Power-over-Ethernet Extender.
 Extend the range of PoE and Ethernet devices an additional 100 meters with each unit.

NOTES:

1. SEE SHEET 2 FOR SPECIFICATIONS.

REGULATORY COMPLIANCE:
EU RoHS DIRECTIVE (MOST RECENTLY RELEASED VERSION).

THE INFORMATION CONTAINED IN THIS DRAWING IS THE SOLE PROPERTY OF INFINITE ELECTRONICS, INC. ANY REPRODUCTION IN PART OR WHOLE WITHOUT THE WRITTEN PERMISSION OF INFINITE ELECTRONICS, INC. IS PROHIBITED. THESE COMMODITIES, TECHNOLOGY OR SOFTWARE WERE EXPORTED FROM THE UNITED STATES IN ACCORDANCE WITH THE EXPORT ADMINISTRATION REGULATIONS. DIVERSION CONTRARY TO U.S. LAW PROHIBITED.

UNLESS OTHERWISE SPECIFIED LEADING DIMENSIONS ARE INCHES DIMENSIONS IN [] ARE MILLIMETERS

TOLERANCES:

.X = ±.2 [5]	FRACTIONS
.XX = ±.02 [0.5]	± 1/32
.XXX = ±.005 [0.13]	ANGLES ± 1°

CABLE LENGTH TOLERANCES:

≤12 [305]	= +1 [25] / -0
>12 [305] ≤ 60 [1524]	= +2 [51] / -0
>60 [1524] ≤ 120 [3048]	= +4 [102] / -0
>120 [3048] ≤ 300 [7620]	= +6 [152] / -0
>300 [7620]	= +5% / -0

ALL DIMENSIONS ARE FOR REFERENCE ONLY AND SUBJECT TO CHANGE WITHOUT NOTICE. UN-DIMENSIONED/NON-CRITICAL FEATURES MAY VARY IN SIZE AND LOCATION. COLORS MAY VARY.



Website: www.L-com.com
Phone: 1.800.341.5266 | 1.978.682.6936

<p>INTERPRET ALL DIMENSIONS AND TOLERANCES PER ASME Y14.5</p>	
SCALE	SHEET
NONE	1 OF 2

DESCRIPTION				
POE EXTENDER, 1-PORT, GIGABIT 10/100/1000 IEEE 802.AT OR 802.AF, UP TO 30W, UP TO 100 METER EXTENSION				
SIZE	CAGE CODE	DRAWN BY	ITEM NO.	REV
A	43321	AKRESOWSKI	POE1GAT-EXT	A

6

5

4

3

2

1

6

5

4

3

2

1

F

F

E

E

D

D

C

C

B

B

A

A

SPECIFICATIONS		MAXIMUM LENGTH		
ITEM	DESCRIPTION	PoE DEVICE (PD)	PoE INJECTOR SWITCH 1EEE802.3af (MAX 15.4W)	PoE INJECTOR SWITCH 1EEE802.3at (MAX 30W)
NO. OF CHANNELS	1			
PASS THROUGH DATA RATES	10/100/1000 Mbps HALF/FULL DUPLEX	IEEE802.3af CLASS 1 NO MORE THAN 4W	400 METERS (3 UNITS PoE EXTENDER)	500 METERS (4 UNITS PoE EXTENDER)
PoE INPUT	PIN ASSIGNMENT AND POLARITY: BOTH 1/2 (-), 3/6 (+) AND 7/8 (-), 4/5 (+)	IEEE802.3af CLASS 2 NO MORE THAN 6W	300 METERS (2 UNITS PoE EXTENDER)	400 METERS (3 UNITS PoE EXTENDER)
PoE OUTPUT	PIN ASSIGNMENT AND POLARITY: 1/2 (-), 3/6 (+) OUTPUT POWER: UP TO 22 W	IEEE802.3af CLASS 0 AND 3 NO MORE THAN 12W	200 METERS (1 UNIT PoE EXTENDER)	300 METERS (2 UNITS PoE EXTENDER)
CONNECTORS	SHIELDED RJ45, EIA 568A AND 568B	IEEE802.3af NO MORE THAN 22W	NOT APPLICABLE	200 METERS (1 UNIT PoE EXTENDER)
NETWORK CABLES	SHIELDED CATEGORY 5 (OR HIGHER)			
DIMENSIONS	130 mm X 48 mm X 34.5 mm			
WEIGHT	0.085 Kg			
MOUNTING	WALL OR SHELF			
LED	RJ45 IN: LINK/ACT, ORN LED (ETHERNET DATA) PoE IN STATUS, GRN LED (POWER) RJ45 OUT: LINK/ACT, GRN LED (ETHERNET DATA) PoE OUT STATUS, ORN LED (POWER)			
ENVIRONMENT	INDOOR			
ENVIRONMENTAL CONDITIONS	OPERATING AMBIENT TEMPERATURE: -10° TO 45° C OPERATING HUMIDITY: MAX 90%, NON-CONDENSING STORAGE TEMPERATURE: -20° TO 70° C STORAGE HUMIDITY: MAX 95%, NON-CONDENSING			
REGULATORY COMPLIANCE	IEEE 802.3af (PoE), IEEE 802.3at (PoE+) RoHS COMPLIANT, CE, FCC			
ELECTROMAGNETIC	FCC PART 15, CLASS B			
IEEE STANDARDS	IEEE 802.3af (POWER OVER ETHERNET) IEEE 802.3at (HIGH POWER OVER ETHERNET) IEEE 802.3 (10Base-T ETHERNET) IEEE 802.3ab (GIGABIT ETHERNET) IEEE 802.3u (100Base-TX FAST ETHERNET) IEEE 802.3x (FLOW CONTROL, FOR FULL DUPLEX MODE)			
MEDIA STANDARDS	100BASE-TX CAT5 UTP RJ45, 8-PIN 1000BASE-TX CAT5E/6 UTP RJ45, 8-PIN			
PORTS	ONE RJ45 10/100/1000 Mbps DATA+POWER INPUT PORT ONE RJ45 10/100/1000 Mbps DATA+POWER OUTPUT PORT			
PROTECTION FUNCTIONS	SHORT CIRCUIT PROTECTIONS FOR SHORT GND OVERLOAD PROTECTIONS FOR CURRENTS OVER 0.6A			

THE INFORMATION CONTAINED IN THIS DRAWING IS THE SOLE PROPERTY OF INFINITE ELECTRONICS, INC. ANY REPRODUCTION IN PART OR WHOLE WITHOUT THE WRITTEN PERMISSION OF INFINITE ELECTRONICS, INC. IS PROHIBITED. THESE COMMODITIES, TECHNOLOGY OR SOFTWARE WERE EXPORTED FROM THE UNITED STATES IN ACCORDANCE WITH THE EXPORT ADMINISTRATION REGULATIONS. DIVERSION CONTRARY TO U.S. LAW PROHIBITED.

ALL DIMENSIONS ARE FOR REFERENCE ONLY AND SUBJECT TO CHANGE WITHOUT NOTICE. UN-DIMENSIONED/NON-CRITICAL FEATURES MAY VARY IN SIZE AND LOCATION. COLORS MAY VARY.

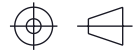
 an INFINIT@ brand Website: www.L-com.com Phone: 1.800.341.5266 1.978.682.6936		 INTERPRET ALL DIMENSIONS AND TOLERANCES PER ASME Y14.5	
		SCALE NONE	SHEET 2 OF 2
DESCRIPTION POE EXTENDER, 1-PORT, GIGABIT 10/100/1000 IEEE 802.AT OR 802.AF, UP TO 30W, UP TO 100 METER EXTENSION			
SIZE A	CAGE CODE 43321	DRAWN BY AKRESOWSKI	ITEM NO. POE1GAT-EXT
			REV A

6

5

4

3

2

1