

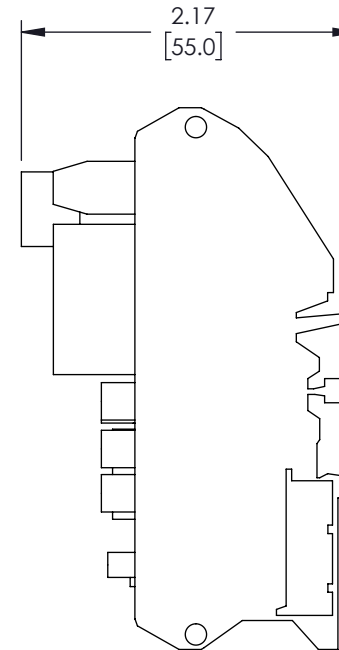

THE INFORMATION CONTAINED IN THIS DRAWING IS THE SOLE PROPERTY OF L-COM, INC. ANY REPRODUCTION IN PART OR WHOLE WITHOUT THE WRITTEN PERMISSION OF L-COM, INC. IS PROHIBITED.

REVISIONS			
REV	DESCRIPTION	DATE	APPROVED
A	INITIAL RELEASE	5/6/2022	THOUGHTON

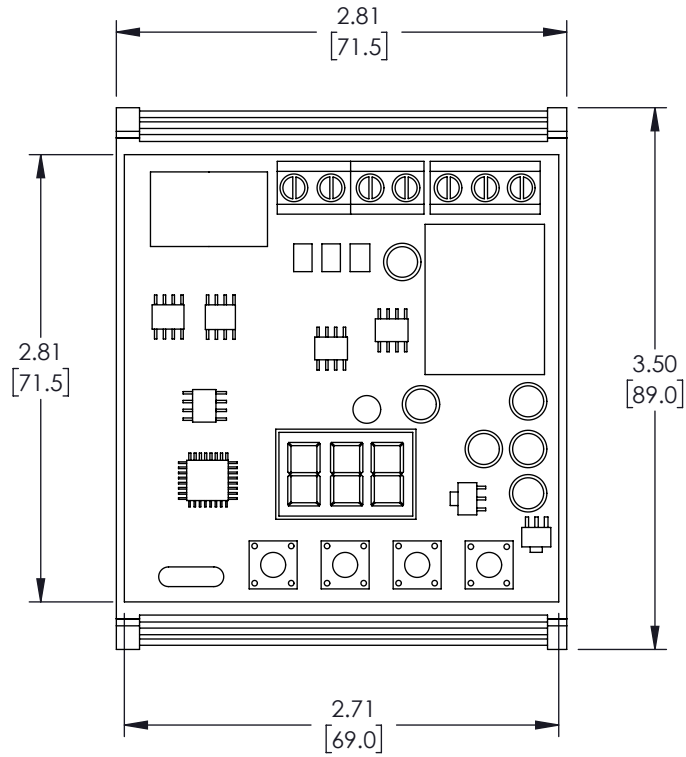

NOTES:

- COMPONENT SHALL BE INDIVIDUALLY PACKAGED IN ACCORDANCE WITH L-COM SPECIFICATION PS-0031.
- NOT ALL COMPONENTS SHOWN FOR CLARITY.

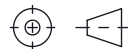
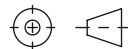
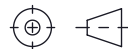
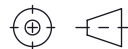
UNLESS OTHERWISE SPECIFIED, DIMENSIONS ARE IN INCHES [mm] OVERALL CABLE LENGTH TOLERANCE: ≤12 [305] = +1 [25] / -0 >12 [305] ≤60 [1524] = +2 [51] / -0 >60 [1524] ≤120 [3048] = +4 [102] / -0 >120 [3048] ≤300 [7620] = +6 [152] / -0 >300 [7620] = +5% / -0 ALL OTHER DIMENSIONAL TOLERANCES: .X = ± .2 [5] FRACTIONS ± 1/32 .XX = ± .02 [.5] ANGLES ± 1° .XXX = ± .005 [.13]	APPROVALS	DATE	 50 High Street, West Mill, North Andover, MA 01845 USA. Phone: 1.800.341.5266 1.978.682.6936
	DRAWN BY DMAY	4/22/2022	
	CHECKED BY HBAKKE	04/22/2022	
	APPROVED BY THOUGHTON	5/6/2022	
THIRD-ANGLE PROJECTION	CONFIGURATION DETAILS OF UNDIMENSIONED FEATURES MAY VARY	PRODUCT DESCRIPTION	CATEGORY
	COLOR VARIATIONS MAY OCCUR	AC CURRENT SENSOR WITH DISPLAY & OVERCURRENT PROTECTION, AC 0-5A	SENSORS
	SCALE: NONE	SIZE A	ITEM NO. SRCN-C710-3
	CAD FILE: SRCN-C710-3.SLDDRW	CAGE CODE 43321	REV. A
	SHEET 1 OF 1		