

SMP Plug Right Angle Non-magnetic Connector Crimp/
Solder Attachment for 0.047 Cable

LCCN45886

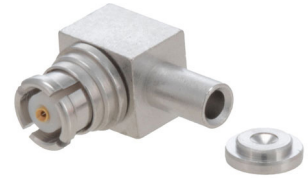

Configuration

- SMP Plug Connector
- 50 Ohms
- Right Angle Body Geometry
- 0.047 Cable Interface Type
- Crimp/Solder Attachment
- Non-Magnetic Design

Features

- Max. Operating Frequency 12.4 GHz
- Excellent VSWR of 1.25:1
- Gold over Copper Plated Beryllium Copper Contact
- Blind Mate Connector
- Magnetic Susceptibility 10^{-5}

Applications

- General Purpose Test
- Custom Cable Assemblies
- Medical
- Military and Aerospace
- Quantum Computing

Description

SMP Non-Magnetic Right Angle Plug Solder type Connector LCCN45886 from L-Com is in stock at our warehouse and ready to ship on the same-day of your order. The LCCN45886 is a SMP Non-magnetic right-angle plug solder type Connector compatible with 0.047 cable. These Non-Magnetic Connector frequency ranges from 0-12.4 GHz with 50 Ohms impedance.

Our RF coaxial connector specialists are available to answer any questions or concerns you have on the LCCN45886 SMP Plug Right Angle Non-Magnetic Connector. Our Non-magnetic connectors have a susceptibility of around 10^{-5} , as opposed to 10^{-2} for standard connectors made of brass/nickel materials. As a result, our non-magnetic connectors are transparent to the magnetic field, which means no field distortion and a higher Signal-to-Noise Ratio (SNR).

Contact L-Com's expert technical support for assistance with the SMP Non-Magnetic right angle plug solder type Connector or any RF coaxial cable connectors or cable assemblies. Download our LCCN45886 datasheet with specifications and CAD drawing with dimensions for details. Our knowledgeable sales team simplifies the purchasing process and ensures that your SMP Non-magnetic RF coaxial connector will be exact to your specifications. The target audience for the right-angle coaxial plug is for quantum computing, the military and aerospace industries as well as the medical industry including MRI and patient monitoring devices.

The LCCN45886 connector from L-Com uses a dedicated manufacturing process, specific gold/copper non-magnetic plating, and raw material selection to guarantee the low magnetic susceptibility level of the connectors. The SMP right angle RF coax connector is available now from L-Com. We have no MOQ (minimum order quantity) and the connector ships the very same day from our warehouse.

Electrical Specifications

Description	Minimum	Typical	Maximum	Units
Frequency Range	DC		12.4	GHz
VSWR			1.25:1	
Insertion Loss			0.12	dB
Operating Voltage (AC)			250	Vrms
Dielectric Withstanding Voltage (AC)			500	Vrms
Insulation Resistance	5,000			MOhms

Click the following link (or enter part number in "SEARCH" on website) to obtain additional part information including price, inventory and certifications:
[SMP Plug Right Angle Non-magnetic Connector Crimp/Solder Attachment for 0.047 Cable LCCN45886](#)

SMP Plug Right Angle Non-magnetic Connector Crimp/
Solder Attachment for 0.047 Cable

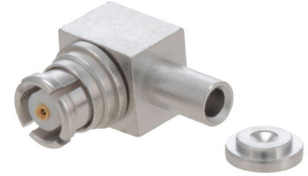

LCCN45886

Mechanical Specifications

Size

Length	0.30 in [7.60 mm]
Width	0.26 in [6.70 mm]
Height	0.26 in [6.70 mm]
Weight	0.00 lbs [0.54 g]
Mating Cycles	500 Cycles

Material Specifications

Description	Material	Plating
Contact	Beryllium Copper	Gold over Copper
Body	Bronze	Copper-Tin-Zinc Alloy over Silver

Environmental Specifications

Temperature

Operating Range	-55deg C to +105deg C
-----------------	-----------------------

Click the following link (or enter part number in "SEARCH" on website) to obtain additional part information including price, inventory and certifications:
[SMP Plug Right Angle Non-magnetic Connector Crimp/Solder Attachment for 0.047 Cable LCCN45886](#)

SMP Plug Right Angle Non-magnetic Connector Crimp/
Solder Attachment for 0.047 Cable

LCCN45886

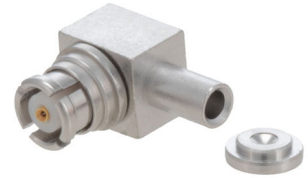

Compliance Certifications (see [product page](#) for current document)

Plotted and Other Data

Assembly Instruction

Click the following link (or enter part number in "SEARCH" on website) to obtain additional part information including price, inventory and certifications:
[SMP Plug Right Angle Non-magnetic Connector Crimp/Solder Attachment for 0.047 Cable LCCN45886](#)

SMP Plug Right Angle Non-magnetic Connector Crimp/
Solder Attachment for 0.047 Cable

LCCN45886

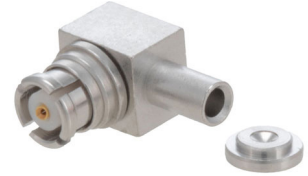

COMPONENT

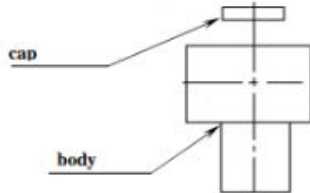

STRIPPING CABLES



We recommend a thermal preconditioning cable

1

Strip the dielectric of the cable .
Clean the cable .
Soldering Sn Pb 180°
Temperature stoking do not exceeded 250° max



2

Slide cable and connector onto the soldering jig.
Slide cable into connector until it bottoms againsts the body and tighten.
Solder the body onto the cable .

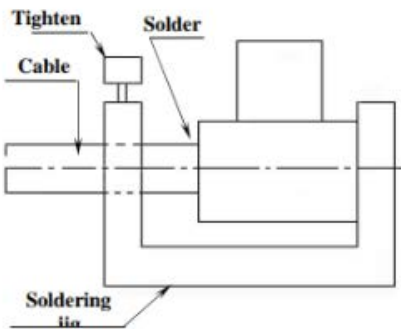

3

After cooling remove cable assembly from the jig .
Slide body into positioner until it bottoms againsts the positioner .
Slide cable assembly onto the jig .
Tighten and solder the contact.
After cooling remove cable assembly from the jig.

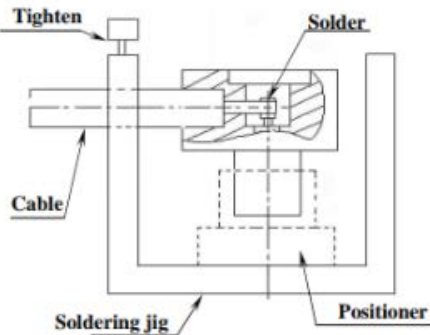

4

Place cable assembly into a dia D = 3.8 ±0.1 and thickness E = 4 ±0.1 .
Place cable assembly above a flat pressing tool .
To fit the cap until it bottoms againsts the body .
(direction F)

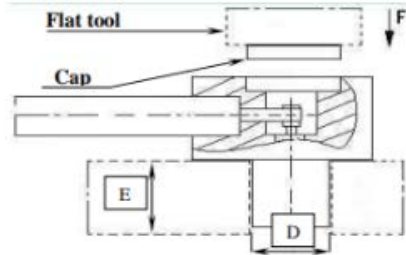

Click the following link (or enter part number in "SEARCH" on website) to obtain additional part information including price, inventory and certifications:
[SMP Plug Right Angle Non-magnetic Connector Crimp/Solder Attachment for 0.047 Cable LCCN45886](#)

SMP Plug Right Angle Non-magnetic Connector Crimp/
Solder Attachment for 0.047 Cable

LCCN45886



SMP Plug Right Angle Non-magnetic Connector Crimp/Solder Attachment for 0.047 Cable from L-com has same day shipment for domestic and International orders. Our portfolio includes coaxial cable assemblies, connectors, adapters and custom products as well as lightning and surge protectors, NEMA rated enclosures, and an RF product line which includes antennas, amplifiers, passive, and active components. Click the following link (or enter part number in "SEARCH" on website) to obtain additional part information including price, inventory and certifications: SMP Plug Right Angle Non-magnetic Connector Crimp/Solder Attachment for 0.047 Cable LCCN45886

URL: <https://www.l-com.com/smp-plug-right-angle-non-magnetic-connector-crimp-solder-attachment-0.047-cable-lccn45886-p.aspx>

The information contained within this document is accurate to the best of our knowledge and representative of the part described herein. It may be necessary to make modifications to the part and/or the documentation of the part in order to implement improvements. L-com reserves the right to make such changes as required. Unless otherwise stated, all specifications are nominal. L-com does not make any representation or warranty regarding the suitability of the part described herein for any particular purpose, and L-com does not assume liability arising out of the use of any part or document. The information contained within this document is accurate to the best of our knowledge and representative of the part described herein. It may be necessary to make modifications to the part and/or the documentation of the part in order to implement improvements. L-com reserves the right to make such changes as required. Unless otherwise stated, all specifications are nominal. L-com does not make any representation or warranty regarding the suitability of the part described herein for any particular purpose, and L-com does not assume liability arising out of the use of any part or document.

SMP Plug Right Angle Non-magnetic Connector Crimp/Solder Attachment for 0.047 Cable

L-com CAD Drawing

