

User Manual



ENS1750/ENS1200
version 1.0

Dual Band Long Range Wireless AC1750/AC1200 Outdoor
Access Point

IMPORTANT

To install this Access Point please refer to the **Quick Installation Guide** included in the product packaging.

Table of Contents

Chapter 1 Product Overview.....	4	Wireless Advanced.....	39
Key Features/Introduction.....	5	WPS Mixed-Enterprise: AP/WDS AP Mode.....	40
System Requirements.....	6	Fast Roaming.....	41
Package Contents.....	7	WDS Link Settings.....	42
Technical Specifications.....	8	2.4GHz/5GHz WDS Link Settings.....	42
Physical Interface.....	10	Guest Network Settings.....	43
Chapter 2 Before You Begin.....	11	Fast Handover Settings.....	43
Computer Settings.....	12	Chapter 8 Management	44
Hardware Installation.....	15	Management VLAN Settings.....	45
Mounting the ENS Dual Band series.....	16	Advanced Settings.....	46
Chapter 3 Configuring Your Access Point.....	18	CLI Settings/Email Alert.....	47
Default Settings./Web Configuration.....	19	Time Zone.....	49
Chapter 4 Building a Wireless Network.....	20	Auto Reboot Settings.....	50
Access Point Mode.....	21	Wi-Fi Scheduler.....	51
WDS AP Mode.....	23	Tools.....	52
WDS Bridge Mode.....	24	Account/Firmware.....	54
Chapter 5 Status.....	25	Backup/Restore	55
Main Status.....	26	User Setting	56
Connection.....	28	Log.....	57
Chapter 6 Network	29	Logout/Reset.....	58
Basic IP Settings.....	30	Appendix.....	59
Spanning Tree Protocol Setting.....	31	FCC Interference Statement.....	60
Chapter 7 2.4 GHz/5 GHz Wireless.....	32	CE Interference Statement.....	61
Wireless Settings.....	33	IC Interference Statement.....	64
2.4 GHz/5 GHz Wireless Network.....	34		
2.4GHz/5 GHz SSID Profile.....	36		
Wireless Security.....	37		
Wireless MAC Filtering.....	38		

Chapter 1

Product Overview



Introduction

Key Features

- Up to 29 dBm transmit power enabling long range connectivity
- Supports IEEE802.11ac/a/b/g/n wireless standards
- Can be monitored after deployment with EnGenius EZ Controller™ software for Windows (Free online download)
- Can be used with included power adapter or via PoE with PoE 802.3at - capable switches or injectors
- Dual Band/Three Stream
- Band Steering shifts dual band clients to 5 GHz for better throughput performance
- Secured Guest Network option available

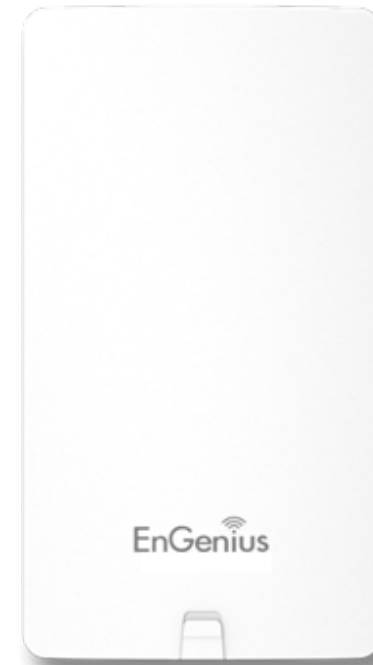

Introduction

The ENS Dual Band series is a high-powered, long-range Dual-Band Wireless 802.11 ac/a/b/g/n Outdoor Access Point with speeds up to 450 Mbps on 2.4GHz and 1300Mbps on 5GHz band. It can be configured as an: Access Point or WDS (AP & Bridge). The ENS Dual Band series is designed to operate in a variety of outdoor environments.

Its high-powered, long-range characteristics make it a cost-effective alternative to ordinary Access Points that don't have the range and reach to connect to a growing number of wireless users who wish to connect to a business network. The ENS Dual Band series supports the 2.4GHz frequency band under 802.11 b/g/n mode while at the

Maximum data rates are based on IEEE 802.11 standards. Actual throughput and range may vary depending on many factors including environmental conditions, distance between devices, radio interference in the operating environment, and mix of devices in the network. Features and specifications subject to change without notice. Trademarks and registered trademarks are the property of their respective owners. For United States of America: Copyright © 2014 EnGenius Technologies, Inc. All rights reserved.

same time providing 5GHz band under 802.11 ac/a/n mode for communicating to and from 5GHz capable computers, tablets or smart phones or transferring files. Several ENS Dual Band series can be deployed in a campus setting using the 5GHz band as a backhaul to provide multiple 2.4GHz wireless cells for computers or mobile devices in common outdoor areas.

The ENS Dual Band series is easy to install in virtually any location with its included PoE (Power over Ethernet) injector for quick outdoor installation. The ENS Dual Band series enables network administrators to control its transmit power and feature settings for selecting narrow bandwidth and traffic shaping. The ENS Dual Band series also supports wireless encryption including Wi-Fi Protected Access (WPA-PSK/WPA2-PSK) Encryption, and IEEE 802.1x with RADIUS.

System Requirements

The following are the Minimum System Requirements in order to configure the device.

- Computer with an Ethernet interface or wireless network capability
- Windows OS (XP, Vista, 7, 8), Mac OS, or Linux-based operating systems
- Web-Browsing Application (i.e.: Internet Explorer, Firefox, Safari, or another similar browser application)

Package Contents

The ENS Dual Band series package contains the following items:*

- ENS Dual Band series Access Point
- Internal Dual Concurrent Omni Antenna
- Power Adapter (48V/0.8A)
- PoE Injector (EPE-4818G)
- Pole Mounting Ring
- Mounting Screw Set
- Quick Installation Guide

*(all items must be in package to issue a refund):

Technical Specifications

Standard:

IEEE802.11ac/a/n on 5 GHz
IEEE802.11b/g/n on 2.4 GHz
IEEE802.3at

Antenna

Internal Dual Concurrent Omni Antenna

Physical Interface

2 x 10/100/1000 Gigabit Ethernet Port with PoE support
LAN1 Port: IEEE802.3at/Proprietary 48V PoE Input
LAN2 Port: Extend Internet Signal

LED Indicator

Power
LAN 1
LAN 2
2.4 GHz
5 GHz

Power Requirements

External Power Adapter, DC IN, 48V/0.8A
IEEE802.3at support

Operation Modes

Access Point
WDS

WDS Detail

WDS AP
WDS Bridge

Optimal Performance

Distance Control (Ack Timeout)
Multicast Supported
Band Steering
Fast Roaming
Auto Channel Selection
BSSID Support

Easily Management

VLAN Tag / VLAN Pass-through
Guest Network
QoS: Complaint with IEEE 802.11e /WMM
RADIUS Accounting
Wireless STA (Client) connection list
Traffic Shaping (Per SSID)

Intuitive Tools

SNMP v1/v2c/v3 support
MIB I/II, Private MIB
Save Configuration as Default
CLI Support
WiFi-Scheduler/Auto Reboot
E-mail Alert

Reinforcement Security

WEP Encryption-64/128/152 bit
WPA/WPA2 Enterprise (WPA-EAP using TKIP or AES)
Hide SSID in beacons
MAC address filtering up to 32 MACs per SSID
Https Support

SSH

Physical/Environment Conditions

Operating:

Temperature: -4 °F to 158 °F (-20 °C to 70 °C)

Humidity (non-condensing): 90% or less

Storage:

Temperature: -22 °F to 176 °F (-30 °C to 80 °C)

Humidity (non-condensing): 90% or less

Physical Interface

Dimensions and Weights

Length: 280.48mm (11.22")

Width: 217.65mm (8.58")

Depth: 55.50mm (2.1")

Weight: 1.88Kg (4.17 lbs)



- 1 **LED Indicators:** LED lights for Power, LAN Port 1, LAN Port 2, 2.4 GHz Connection and 5 GHz Connection.
- 2 **LAN Port 1 (802.3at/48V PoE Input):** Ethernet port for RJ-45 cable.
- 3 **LAN Port 2:** Ethernet port for RJ-45 cable.
- 4 **Reset Button:** **Reset** or **Reboot** the ENS Dual Band Access.
- 5 **Mounting Holes:** Using the provided screw set or pole mounting ring, the ENS Dual Band series can be attached to a wall or pole.

Chapter 2

Before You Begin

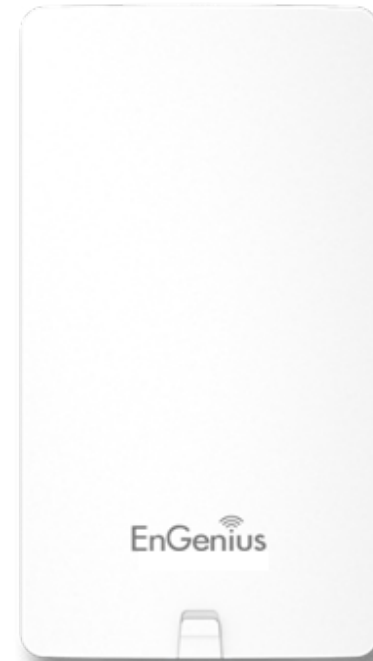

Computer Settings

Windows XP/Windows 7/Windows 8

In order to use the ENS Dual Band series, you must first configure the TCP/IPv4 connection of your Windows OS computer system.

1a. Click the **Start** button and open the **Control Panel**



Windows XP

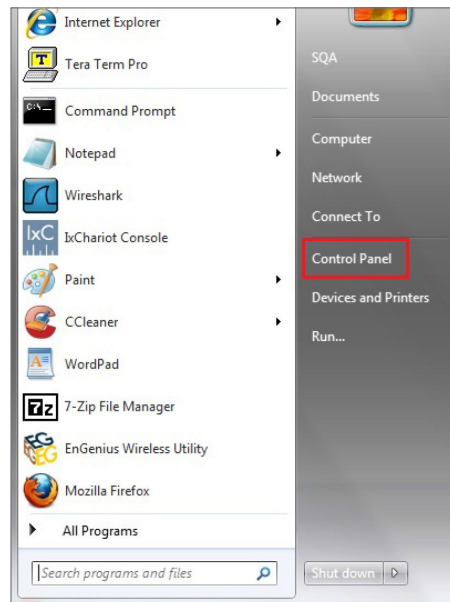

Windows 7

1b. Move your mouse to the lower right hot corner to display the Charms Bar and select the **Control Panel** in Windows 8 OS.

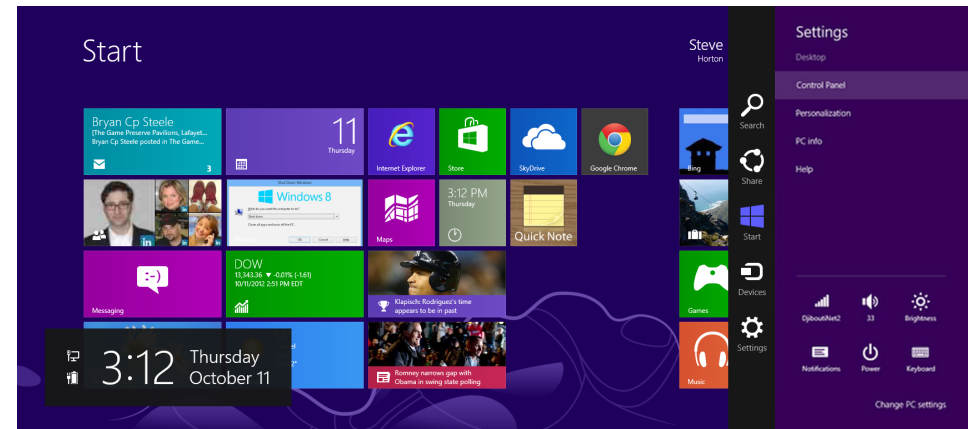

2a. In Windows XP, click **Network Connections**.



2b. In Windows 7/Windows 8, click **View Network Status and Tasks** in the **Network and Internet** section, then select **Change adapter settings**.



Network and Internet
View network status and tasks
Choose homegroup and sharing options

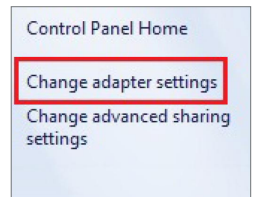

3. Right click on **Local Area Connection** and select **Properties**.

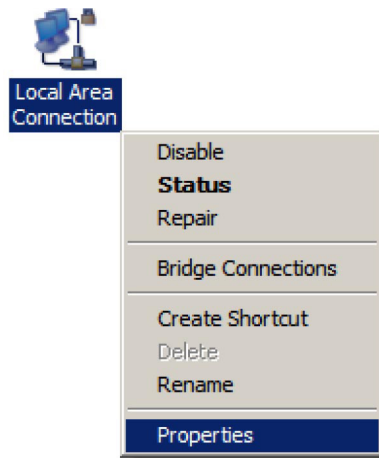

4. Select **Internet Protocol Version 4 (TCP/IPv4)** and then select **Properties**.

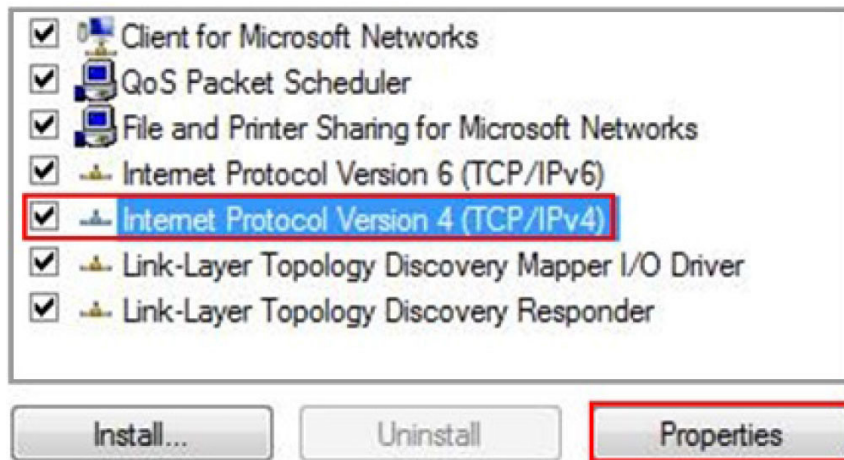

5. Select **Use the following IP address** and enter an IP address that is different from the ENS and Subnet mask, then click **OK**.

Note: Ensure that the IP address and Subnet mask are on the same subnet as the device.

For example: ENS IP address: 192.168.1.1

PC IP address: 192.168.1.2 - 192.168.1.255

PC Subnet mask: 255.255.255.0

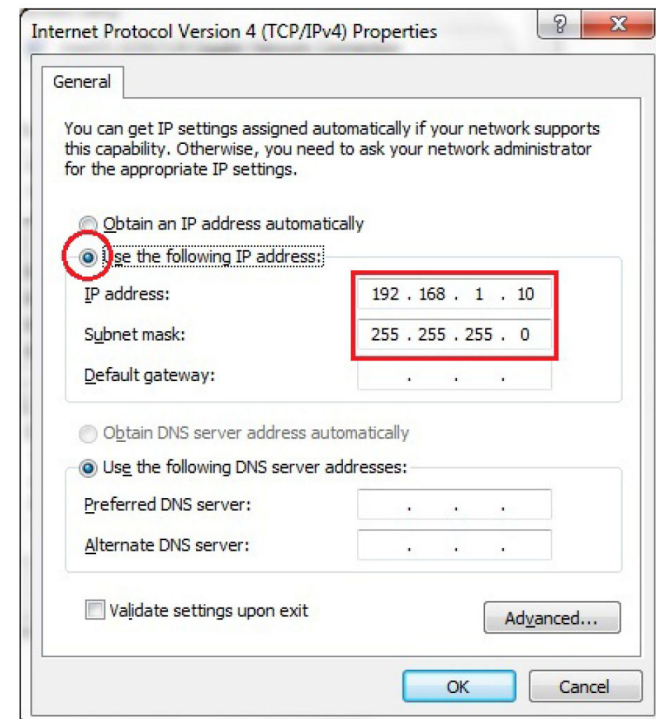

Apple Mac OS X

1. Go to **System Preferences** (Which can be opened in the Applications folder or selecting it in the Apple Menu).
2. Select **Network** in the **Internet & Network** section.



3. Highlight **Ethernet**.

4. In **Configure IPv4**, select **Manually**.

5. Enter an IP address that is different from the ENS Dual Band series and Subnet mask then press **OK**.

Note: Ensure that the IP address and Subnet mask are on the same subnet as the device.

For example: ENS Dual Band series IP address: 192.168.1.1

PC IP address: 192.168.1.2 - 192.168.1.255

PC Subnet mask: 255.255.255.0

6. Click **Apply** when done.

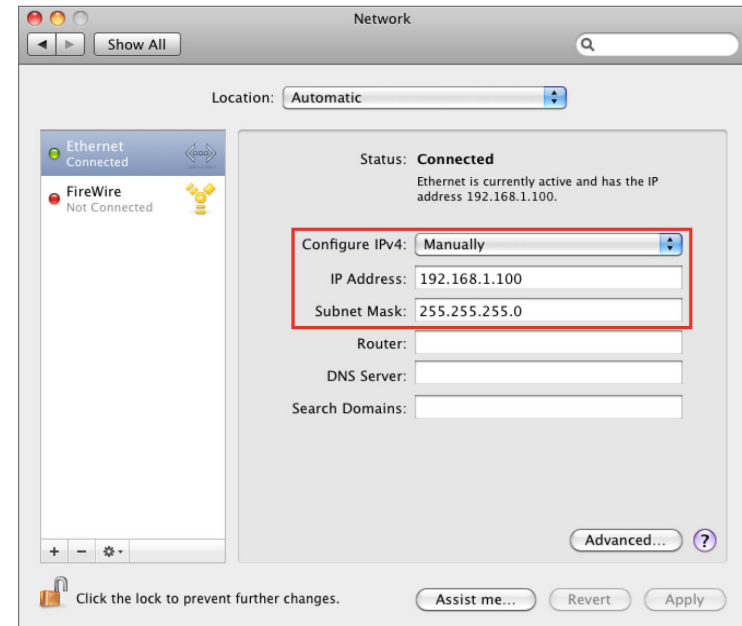

Hardware Installation

1. Connect one end of the Ethernet cable into the main LAN port (PoE) of the Access Point and the other end to the AP Ethernet port on the PoE injector.
2. Connect the **Power Adapter** to the **DC-IN** port of the PoE injector and plug the other end in to an electrical outlet.
3. Connect the second Ethernet cable into the **LAN port** of the PoE injector and the other end to the Ethernet port on the computer.
4. Screw on the provided antennas to the device. Once both connections are secure, verify the following:
 - a) Ensure that the **POWER** light is on (it will be green).
 - b) Ensure that the 2.4 GHz/5 GHz WLAN light is on (it will be green for both 5 GHz and 2.4 GHz).
 - c) Ensure that the LAN (Computer/ENS Dual Band series Connection) light is on (it will be green).
 - d) Once all three lights are on, proceed to set up the Access Point using the computer.

This diagram depicts the hardware configuration.

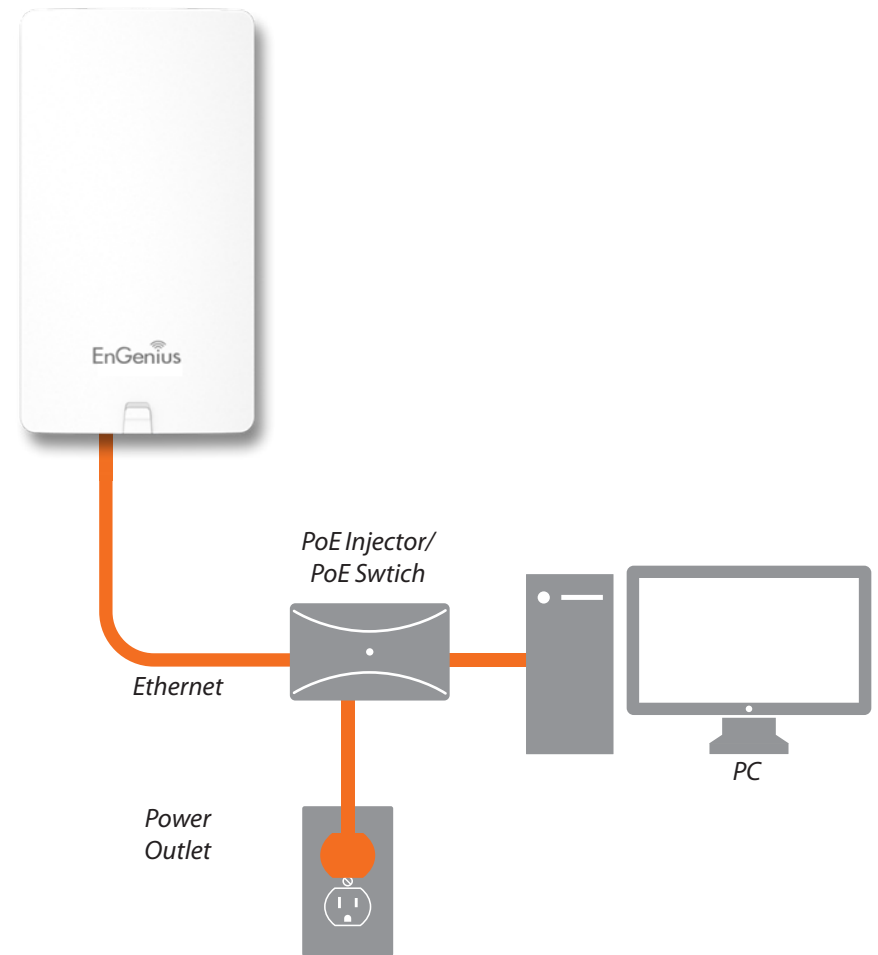

Note: The Access Point supports both IEEE 802.3at PoE (Power over Ethernet) or the included power injector. You may use either one as the power source. **Do NOT use both at the same time.**

To attach the ENS Dual Band series to a wall:

1. Attach the location sticker to the desired location on the wall and use a 6mm drill bit to drill the two marked holes.
2. Insert the screw anchors into the 6mm holes drilled then insert and the screws and tighten.
3. Align the access point over the keyhole mounting slots and insert both screw heads into each keyhole slot. Then slide the access point downward until it's firmly hooked in place.

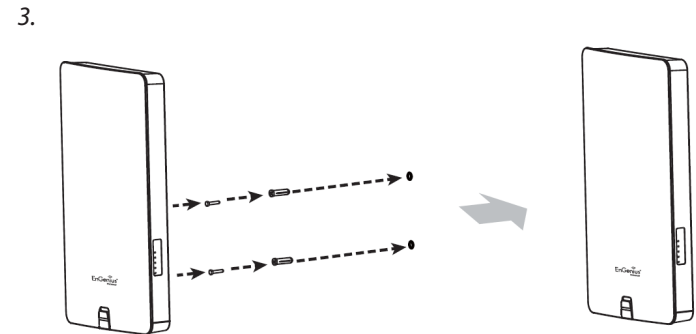
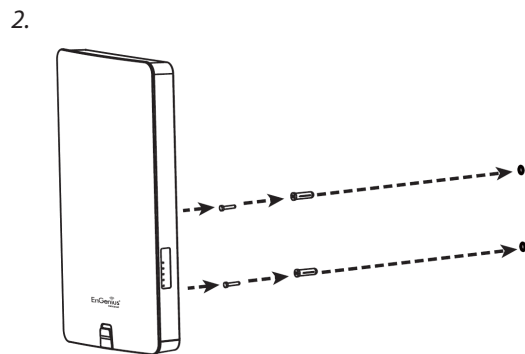
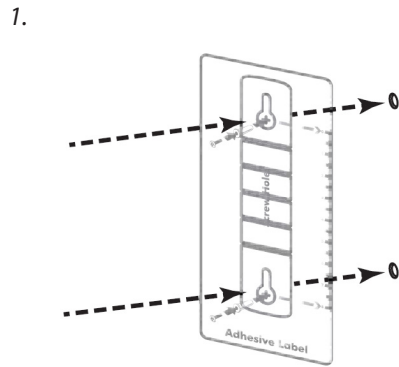

To attach the ENS Dual Band series to a pole using the provided pole mounting Ring:

1. Use a flathead screwdriver to unfasten the screw on the pole mounting ring and thread it through the middle tab on the rear of the access point.
2. Mount the access point onto the pole by wrapping the ring around the pole and fastening the screw.

1.

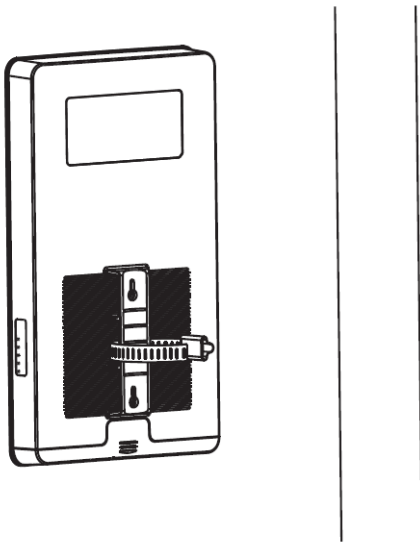

2.

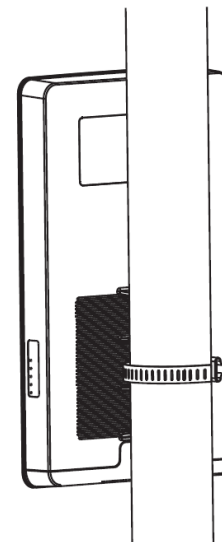

Chapter 3

Configuring Your Access Point

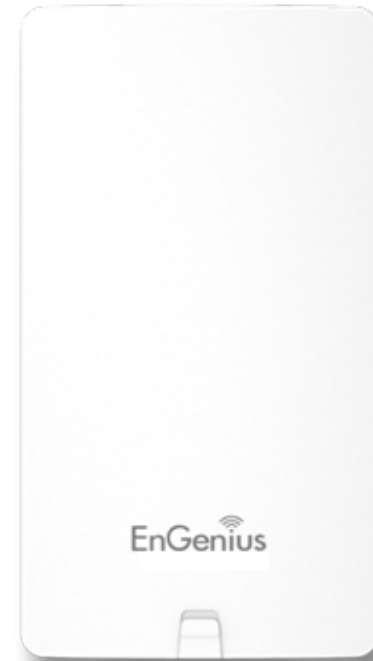

Configuring Your Access Point

This section will show you how to configure the device using the web-based configuration interface.

Default Settings

Please use your Ethernet port or wireless network adapter to connect the Access Point.

IP Address	192.168.1.1
Username / Password	admin / admin

Web Configuration

1. Open a web browser (Internet Explorer/Firefox/Safari/Chrome) and enter the IP Address **http://192.168.1.1**

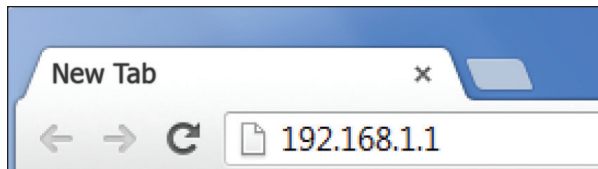

Note: If you have changed the default LAN IP Address of the Access Point, ensure you enter the correct IP Address.

2. The default username and password are **admin**. Once you have entered the correct username and password, click the **Login** button to open the web-base configuration page.



3. If successful, you will be logged in and see the User Interface of the ENS Dual Band series .

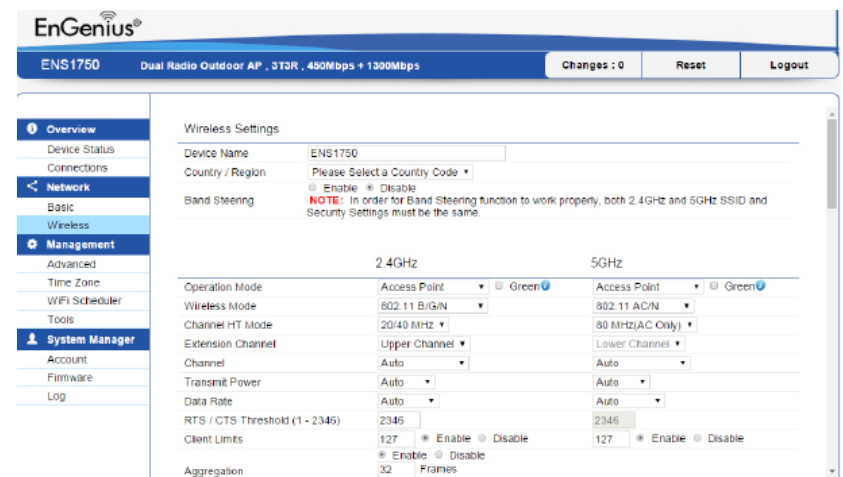

Chapter 4

Building a Wireless Network



The ENS Dual Band series has the ability to operate in various modes. This chapter describes the operating modes of the ENS Dual Band series.

Access Point Mode

In Access Point Mode, ENS Dual Band series behaves like a central connection for stations or clients that support IEEE 802.11a/b/g/n networks. The stations and clients must be configured to use the same SSID (Service Set Identifier) and security password to associate with the ENS Dual Band series. The ENS Dual Band series supports up to eight SSIDs per band at the same time for secure access.

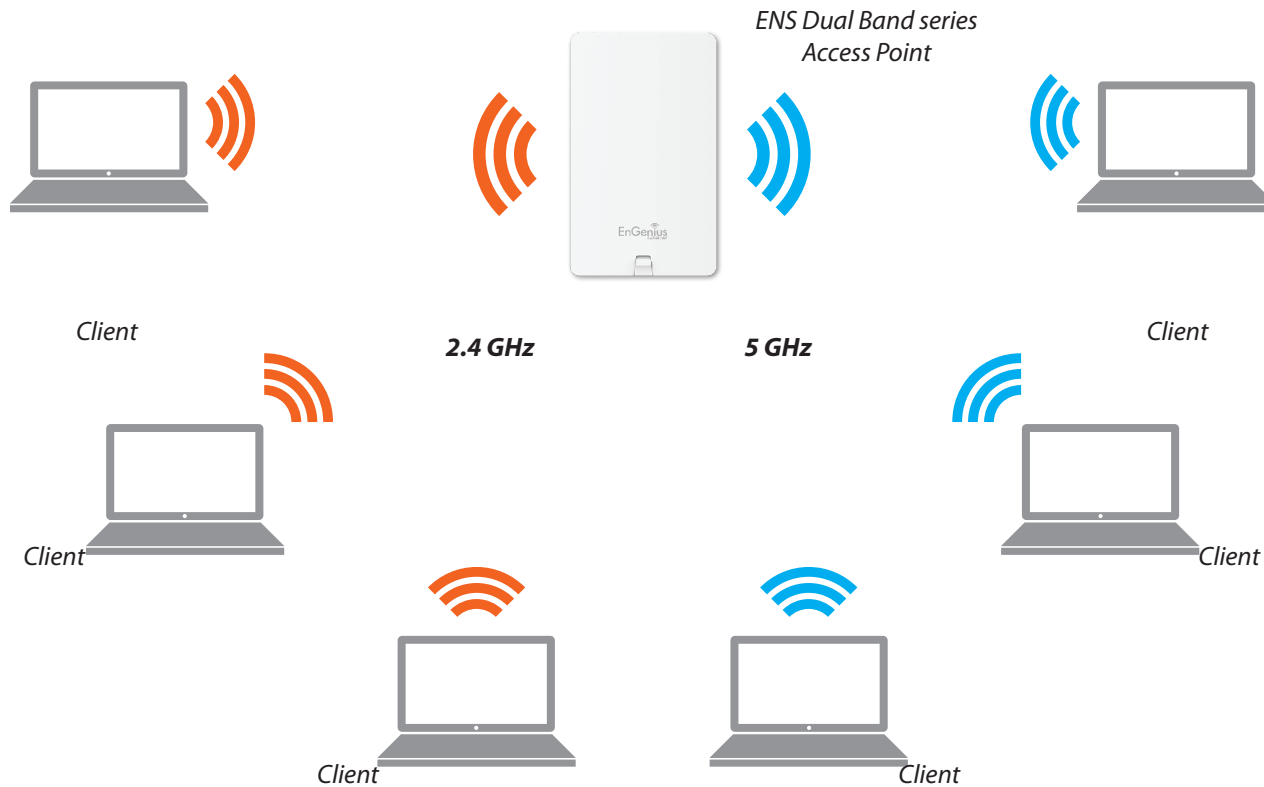

The ENS Dual Band series can be used as a centralized Outdoor Access Point with which other EnGenius Wireless N 2.4 or 5 GHz Outdoor Client Bridges can associate; leveraging the long-range capability of their internal high-gain directional antennas, resulting in a very cost-effective solution to expand a company network over a multiple building campus.

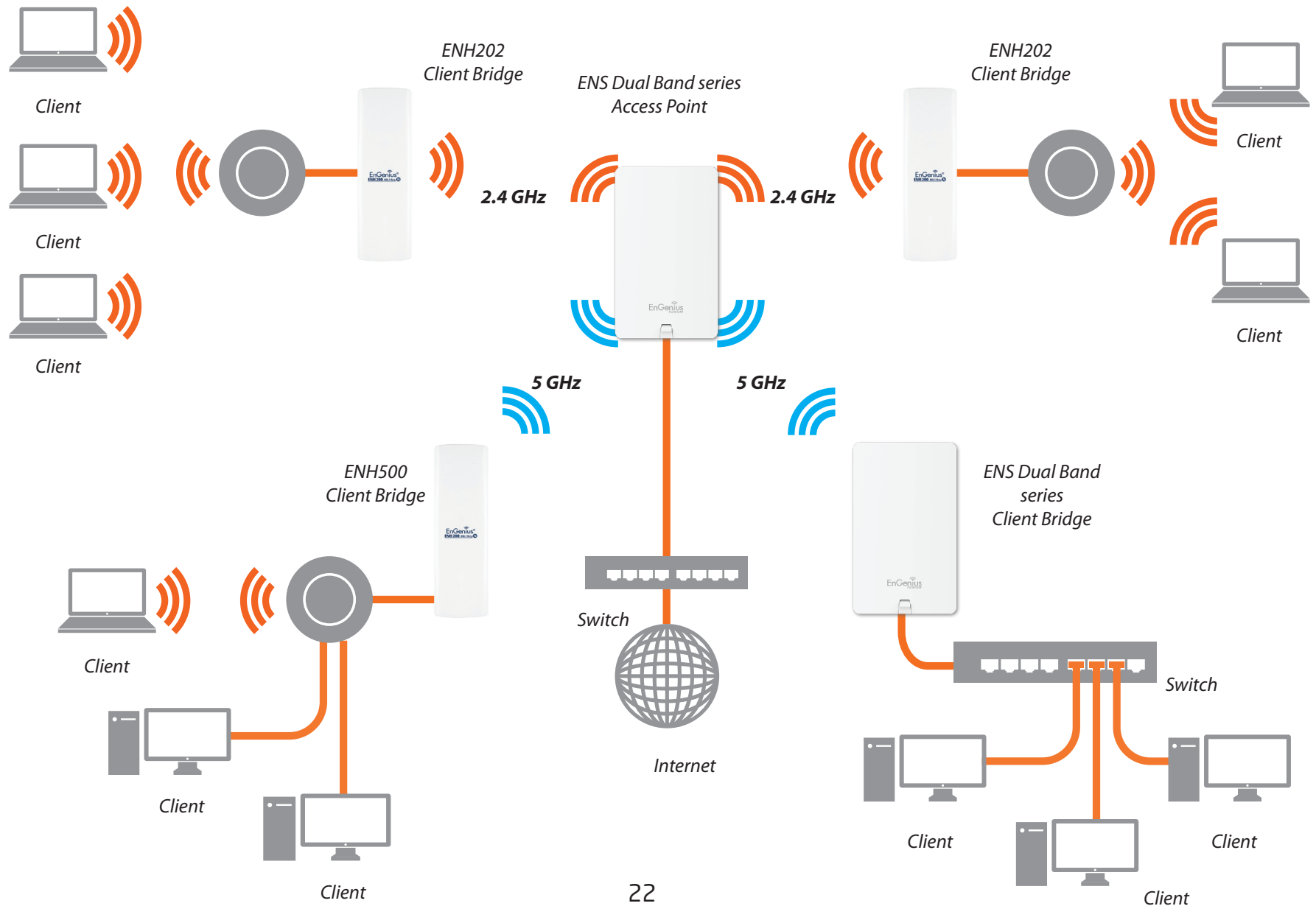

WDS AP Mode

The ENS Dual Band series also supports WDS AP mode. This operating mode allows wireless connections to the ENS Dual Band series using WDS technology. In this mode, configure the MAC addresses in both Access Points to enlarge the wireless area by enabling WDS Link settings. WDS supports up to four (4) AP MAC addresses.

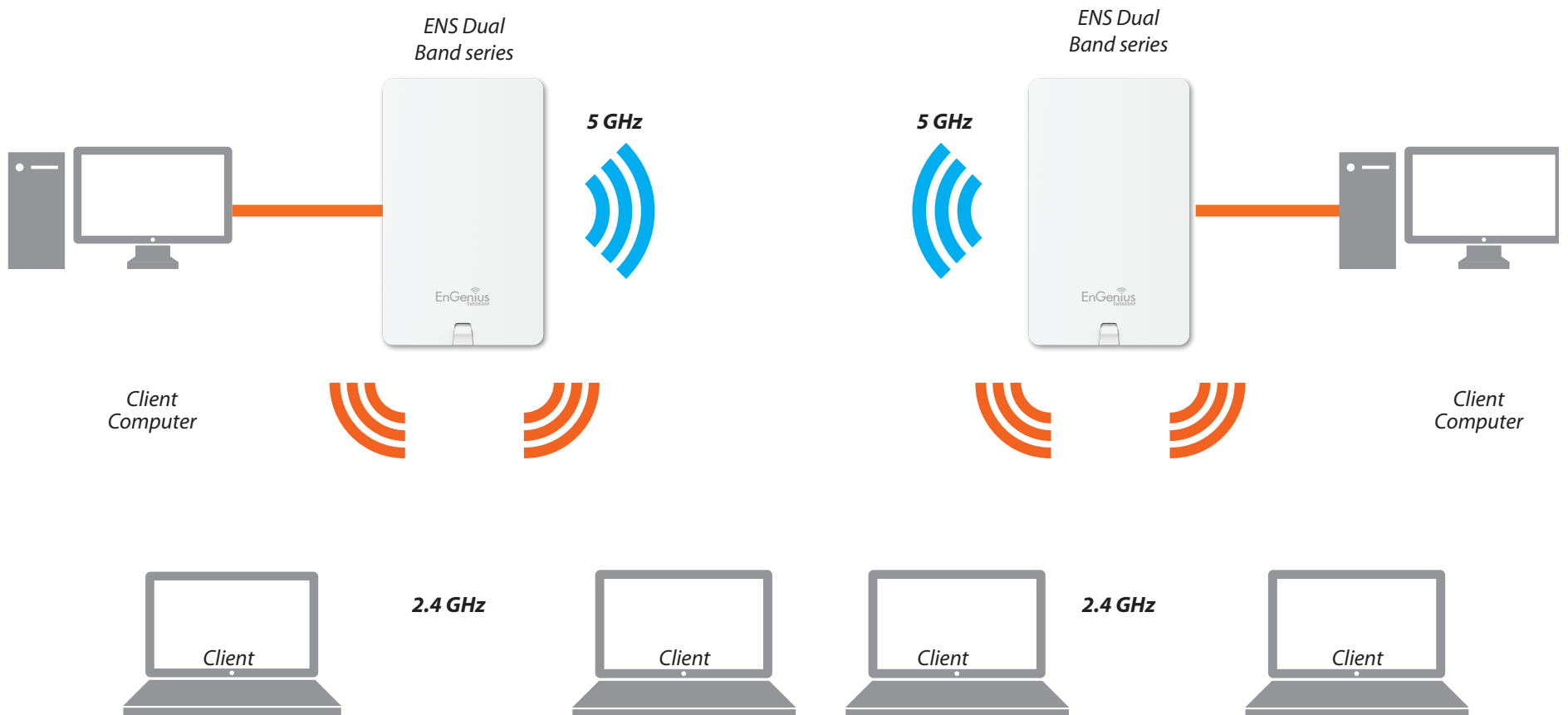

WDS Bridge Mode

In WDS Bridge Mode, the ENS Dual Band series can wirelessly connect different LANs by configuring the MAC address and security settings of each ENS Dual Band series device. Use this mode when two wired LANs located a small distance apart want to communicate with each other. The best solution is to use the ENS Dual Band series to wirelessly connect two wired LANs, as shown in the following diagram.

WDS Bridge Mode can establish up to four WDS links, creating a star-like network.

Note: WDS Bridge Mode does not act as an Access Point. Access Points linked by WDS are using the same frequency channel. More Access Points connected together may lower throughput. This configuration can be susceptible to generate endless network loops in your network, so it is recommended to enable the Spanning Tree function to prevent this from happening.

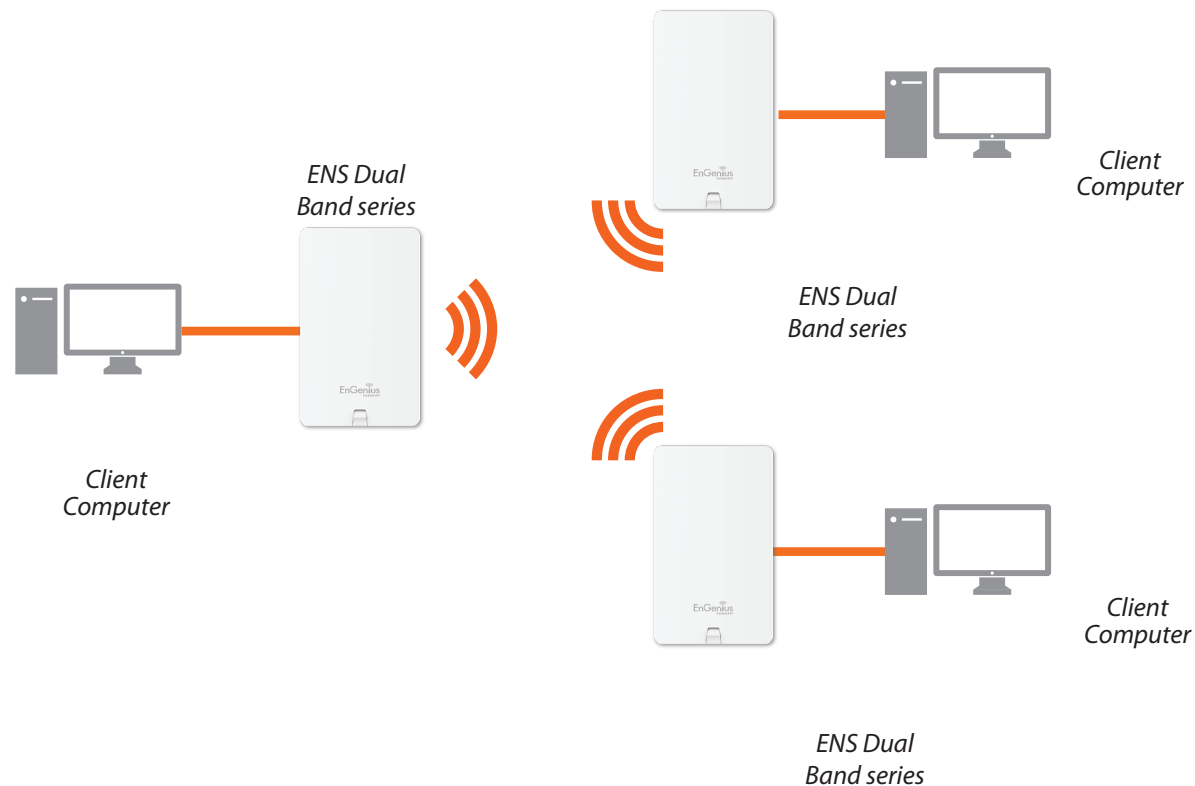

Chapter 5

Status



Main Status

Save Changes

This page lets you save and apply the settings shown under **Unsaved changes list**, or cancel the unsaved changes and revert to the previous settings that were in effect.

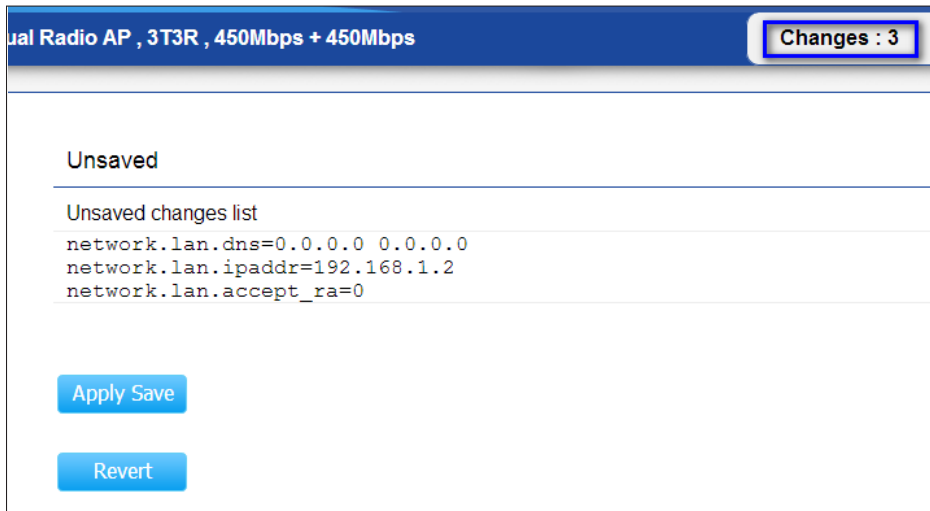

Device Status

Clicking the **Device Status** link under the **Overview** menu shows the status information about the current operating mode.

- The **Device Information** section shows general system information such as Device Name, MAC Address, Current Time, Firmware Version, and Management VLAN ID

Note: VLAN ID is only applicable in Access Point or WDS AP mode.

Device Information	
Device Name	ENH900EXT
MAC Address	
- LAN	88:DC:96:06:3C:94
- Wireless LAN - 2.4GHz	88:DC:96:06:3C:96
- Wireless LAN - 5GHz	88:DC:96:06:3C:97
Country	Default
Current Local Time	Wed Sep 25 03:04:37 UTC 2013
Firmware Version	2.0.0
Management VLAN ID	4096

- The **LAN Information** section shows the Local Area

Network settings such as the LAN IP Address, Subnet mask, and DNS Address.

LAN Information - IPv4	
IP Address	192.168.1.1
Subnet Mask	255.255.255.0
Gateway	192.168.1.1
Primary DNS	0.0.0.0
Secondary DNS	0.0.0.0
DHCP Client	Disable
Spanning Tree Protocol (STP)	Disable

Statistics				
	SSID	MAC	RX(Packets)	TX(Packets)
Ethernet		00:02:6F:FF:FF:FF	75.57KB(856 PKts.)	455.926KB(399 PKts.)
	EnGenius063C96_1-2.4GHz	88:DC:96:06:3C:96	0KB(0 PKts.)	0.792KB(4 PKts.)
	EnGenius063C97_1-5GHz	88:DC:96:06:3C:97	0KB(0 PKts.)	0KB(0 PKts.)

- The **Wireless LAN Information 2.4 GHz/5 GHz** section shows wireless information such as Operating Mode, Frequency, and Channel. Since the ENS Dual Band series supports multiple-SSIDs, information about each SSID, the ESSID, and security settings, are displayed

Note: Profile Settings are only applicable in Access Point and WDS AP modes.

Wireless LAN Information - 2.4GHz					
Operation Mode	AP				
Wireless Mode	802.11 B/G/N				
Channel Bandwidth	20-40 MHz				
Channel	2.437 GHz (Channel 6)				
Distance	1000 M				
Profile	SSID	Security	VID	802.1Q	
#1	EnGenius063C96_1-2.4GHz	None	1	Disable	
#2	EnGenius063C96_2-2.4GHz	None	2	Disable	
#3	EnGenius063C96_3-2.4GHz	None	3	Disable	
#4	EnGenius063C96_4-2.4GHz	None	4	Disable	
#5	EnGenius063C96_5-2.4GHz	None	5	Disable	
#6	EnGenius063C96_6-2.4GHz	None	6	Disable	

Wireless LAN Information - 5GHz					
Operation Mode	AP				
Wireless Mode	802.11 A/N				
Channel Bandwidth	40 MHz				
Channel	5.66 GHz (Channel 132)				
Distance	1000 M				
Profile	SSID	Security	VID	802.1Q	
#1	EnGenius063C97_1-5GHz	None	51	Disable	
#2	EnGenius063C97_2-5GHz	None	52	Disable	
#3	EnGenius063C97_3-5GHz	None	53	Disable	
#4	EnGenius063C97_4-5GHz	None	54	Disable	
#5	EnGenius063C97_5-5GHz	None	55	Disable	
#6	EnGenius063C97_6-5GHz	None	56	Disable	
#7	EnGenius063C97_7-5GHz	None	57	Disable	
#8	EnGenius063C97_8-5GHz	None	58	Disable	

- The **Statistics** section shows Mac information such as SSID, MAC address, RX and TX.

Connection

2.4 GHz/5 GHz Connection List

Click the connection link under the Overview menu displays the connection list of clients associated to the ENS Dual Band series's 2.4 GHz/5 GHz, along with the MAC addresses and signal strength for each client. Clicking **Refresh** updates the client list.

Note: Only applicable in Access Point and WDS AP modes.

2.4 GHz/5 GHz WDS Link List

Click the connection link under the Overview menu. This page displays the current status of the WDS link, including WDS Link ID, MAC Address, Link Status and RSSI.

Note: Only applicable in WDS AP and WDS Bridge modes.

The screenshot shows the EnGenius web interface for an ENH900EXT Dual Radio Outdoor AP. The left sidebar contains a navigation menu with the following items: Overview (selected), Device Status, Connections, Network, Basic, Wireless, Management, Advanced, Time Zone, WiFi Scheduler, Tools, System Manager, Account, Firmware, and Log. The main content area displays the 'Connections' page for the 2.4GHz band. It includes sections for 'Mesh Direct Link Node - 2.4GHz', '2.4GHz Mesh Node', and 'Connection List - 2.4GHz'. The 'Connection List - 2.4GHz' table shows one client connected.

SSID	MAC Address	TX	RX	RSSI	Block
EnGenius160796_1-2.4GHz	B4:52:7E:80:C2:37	0Kb	0Kb	-96dBm	<input type="button" value="Kick"/>

Chapter 6

Network



Basic IP Settings

IPv4/IPv6 Settings

This page allows you to modify the device's IP settings.

IPv4 Settings	
IP Network Setting	Static IP ▾
IP Address	192.168.1.1
Subnet Mask	255.255.255.0
Gateway	192.168.1.1
Primary DNS	0.0.0.0
Secondary DNS	0.0.0.0
IPv6 Settings	<input checked="" type="checkbox"/> Link-local Address
IP Address	
Subnet Prefix Length	
Gateway	
Primary DNS	
Secondary DNS	

IP Network Settings: Select whether the device IP address will use a static IP address specified in the IP address field or be obtained automatically when the device connects to a DHCP server.

IP Address: The IP address of this device.

Subnet Mask: The IP Subnet mask of this device.

Gateway: The Default Gateway of this device. Leave it blank if you are unsure of this setting.

Primary/Secondary DNS: The primary/secondary DNS address for this device.

Save: Click **Save** to confirm the changes.

Spanning Tree Protocol (STP) Settings

This page allows you to modify the Spanning Tree settings. Enabling the Spanning Tree protocol will prevent network loops in your LAN network.

Spanning Tree Protocol (STP) Settings		
Status	<input type="text" value="Disable"/>	
Hello Time	<input type="text" value="2"/>	seconds (1-10)
Max Age	<input type="text" value="20"/>	seconds (6-40)
Forward Delay	<input type="text" value="4"/>	seconds (4-30)
Priority	<input type="text" value="32768"/>	(0-65535)

Spanning Tree Status: Enables or disables the Spanning Tree function.

Hello Time: Specifies Bridge Hello Time in seconds. This value determines how often the device sends handshake packets to communicate information about the topology throughout the entire Bridged Local Area Network.

Max Age: Specifies Bridge Max Age in seconds. If another bridge in the spanning tree does not send a hello packet for a long period of time, it is assumed to be inactive.

Forward Delay: Specifies Bridge Forward Delay in seconds. Forwarding delay time is the time spent in each of the Listening and Learning states before the Forwarding state is entered. This delay is provided so that when a new bridge comes onto a busy network, it analyzes data traffic before participating in the network.

Priority: Specifies the Priority Number. A smaller number has a greater priority than a larger number.

Save: Click **Save** to confirm the changes.

Chapter 7

2.4 GHz & 5 GHz Wireless



Wireless

Wireless Settings

Wireless Settings	
Device Name	<input type="text" value="ENS1750"/>
Country / Region	<input type="text" value="United States"/> ▼
Band Steering	<input type="radio"/> Enable <input checked="" type="radio"/> Disable NOTE: In order for Band Steering function to work properly, both 2.4GHz and 5GHz SSID and security settings must be the same.

Device Name: Enter a name for the device. The name you type appears in SNMP management. This name is not the SSID and is not broadcast to other devices.

Band Steering: Enable Band Steering to send 802.11n clients to the 5 GHz band, where 802.11b/g clients cannot go, and leave 802.11b/g clients in 2.4GHz to operate at their slower rates. Band Steering works within the Access Point by directing 5 GHz-capable clients to that band.

Save: Click **Save** to confirm the changes.

This page displays the current status of the Wireless settings of the ENS Dual Band series.

2.4 GHz/5 GHz Wireless Network

	2.4GHz	5GHz
Operation Mode	Access Point <input type="checkbox"/> Green	Access Point <input type="checkbox"/> Green
Wireless Mode	802.11 B/G/N	802.11 A/N
Channel HT Mode	20/40 MHz	40 MHz
Extension Channel	Upper Channel	Lower Channel
Channel	Auto	Auto
Transmit Power	20 dBm	20 dBm
Data Rate	Auto	Auto
RTS / CTS Threshold (1 - 2346)	2346	2346
Client Limits	127 Enable	127 Enable
Aggregation	Enable	Enable
	32 Frames	32 Frames
	50000 Bytes(Max)	50000 Bytes(Max)
AP Detection	Scan	Scan
Distance (1-30km)	1	1

Operation Mode: Select **Operation Mode**. The ENS Dual Band series supports three different operation modes: Access Point, or WDS (WDS AP, WDS Bridge, and WDS Station).

Wireless Mode: Supports 802.11b/g/n mixed mode in 2.4 GHz and 802.11ac/a/n mixed mode in 5 GHz.

Channel HT Mode: The default channel bandwidth is 20 MHz/ 40 MHz. The larger the channel, the greater the

transmission quality and speed.

Extension Channel: Select upper or lower channel. Your selection may affect the Auto channel function.

Transmit Power: Sets the power output of the wireless signal.

Data Rate: Select a data rate from the drop-down list. The data rate affects throughput of data in the ENS Dual Band series. Select the best balance for you and your network but note that the lower the data rate, the lower the throughput, though transmission distance is also lowered.

RTS/CTS Threshold: Specifies the threshold package size for RTC/CTS. A small number causes RTS/CTS packets to be sent more often and consumes more bandwidth.

Client Limits: Limits the total number of clients.

Aggregation: Merges data packets into one packet. This option reduces the number of packets, but also increases packet sizes.

AP Detection: AP Detection can select the best channel to use by scanning nearby areas for Access Points.

Distance: Specifies the distance between Access Points and clients. Note that longer distances may drop higher-speed connections.

Save: Click **Save** to confirm the changes or **Cancel** to cancel and return to previous settings.

2.4 GHz/5 GHz SSID Profile

Wireless Settings - 2.4GHz								
No.	Enable	SSID	Edit	Security	Suppressed SSID	Station Separation	Isolation	VID
1	<input checked="" type="checkbox"/>	EnGenius063C96_1-2.4GHz	Edit	None	<input type="checkbox"/>	<input type="checkbox"/>	<input type="checkbox"/>	1
2	<input type="checkbox"/>	EnGenius063C96_2-2.4GHz	Edit	None	<input type="checkbox"/>	<input type="checkbox"/>	<input type="checkbox"/>	2
3	<input type="checkbox"/>	EnGenius063C96_3-2.4GHz	Edit	None	<input type="checkbox"/>	<input type="checkbox"/>	<input type="checkbox"/>	3
4	<input type="checkbox"/>	EnGenius063C96_4-2.4GHz	Edit	None	<input type="checkbox"/>	<input type="checkbox"/>	<input type="checkbox"/>	4
5	<input type="checkbox"/>	EnGenius063C96_5-2.4GHz	Edit	None	<input type="checkbox"/>	<input type="checkbox"/>	<input type="checkbox"/>	5
6	<input type="checkbox"/>	EnGenius063C96_6-2.4GHz	Edit	None	<input type="checkbox"/>	<input type="checkbox"/>	<input type="checkbox"/>	6
7	<input type="checkbox"/>	EnGenius063C96_7-2.4GHz	Edit	None	<input type="checkbox"/>	<input type="checkbox"/>	<input type="checkbox"/>	7
8	<input type="checkbox"/>	EnGenius063C96_8-2.4GHz	Edit	None	<input type="checkbox"/>	<input type="checkbox"/>	<input type="checkbox"/>	8

Wireless Settings - 5GHz								
No.	Enable	SSID	Edit	Security	Suppressed SSID	Station Separation	Isolation	VID
1	<input checked="" type="checkbox"/>	EnGenius063C97_1-5GHz	Edit	None	<input type="checkbox"/>	<input type="checkbox"/>	<input type="checkbox"/>	51
2	<input type="checkbox"/>	EnGenius063C97_2-5GHz	Edit	None	<input type="checkbox"/>	<input type="checkbox"/>	<input type="checkbox"/>	52
3	<input type="checkbox"/>	EnGenius063C97_3-5GHz	Edit	None	<input type="checkbox"/>	<input type="checkbox"/>	<input type="checkbox"/>	53
4	<input type="checkbox"/>	EnGenius063C97_4-5GHz	Edit	None	<input type="checkbox"/>	<input type="checkbox"/>	<input type="checkbox"/>	54
5	<input type="checkbox"/>	EnGenius063C97_5-5GHz	Edit	None	<input type="checkbox"/>	<input type="checkbox"/>	<input type="checkbox"/>	55
6	<input type="checkbox"/>	EnGenius063C97_6-5GHz	Edit	None	<input type="checkbox"/>	<input type="checkbox"/>	<input type="checkbox"/>	56
7	<input type="checkbox"/>	EnGenius063C97_7-5GHz	Edit	None	<input type="checkbox"/>	<input type="checkbox"/>	<input type="checkbox"/>	57
8	<input type="checkbox"/>	EnGenius063C97_8-5GHz	Edit	None	<input type="checkbox"/>	<input type="checkbox"/>	<input type="checkbox"/>	58

Current Profile: You can configure up to sixteen (16) different SSIDs (eight (8) per band). If multiple client devices will be accessing the network, you can arrange the devices into SSID groups. Click **Edit** to configure the profile and check whether you want to enable extra SSID.

SSID: Specifies the SSID for the current profile.

Suppressed SSID: Check this option to hide the SSID from clients. If checked, the SSID will not appear in the site survey.

Station Separation: Click the appropriate radio button to allow or prevent communication between client devices.

VID: Specifies the VLAN tag for each profile. If your network includes VLANs, you can specify a VLAN ID for packets pass through the Access Point with a tag.

Wireless Security: See the Wireless Security section.

Isolation: Restrict clients communicating with different VIDs by selecting the radio button.

Save: Click **Save** to accept the changes.

Wireless Security

The Wireless Security section lets you configure the ENS Dual Band series's security modes: WEP, WPA-PSK, WPA2-PSK, WPA-PSK Mixed, WPA, WPA2, and WPA Mixed. It is strongly recommend that you use WPA2-PSK.

Wireless Security - 2.4G	
Security Mode	WEP
Auth Type	Open System
Input Type	Hex
Key Length	40/64-bit (10 hex digits or 5 ASCII char)
Default Key	1
Key1	
Key2	
Key3	
Key4	

Auth Type: Select **Open System** or **Shared Key**.

Input Type:

ASCII: Regular Text (recommended)

Hexadecimal Numbers (For advanced users)

Key Length: Select the desired option and ensure that wireless clients use the same setting. Your choices are 64, 128, and 152-bit password lengths.

Default Key: Select the Key you wish to be the default. Transmitted data is **ALWAYS** encrypted using the Default Key; the other Keys are for decryption only. You must enter a Key Value for the Default Key.

Encryption Key Number: Enter the Key Value or values you wish to use. Only the Key selected as Default is required. The others are optional.

Wireless MAC Filtering

Wireless MAC Filtering is used to allow or deny network access to wireless clients (computers, tablet PCs, NAS, smartphones, etc.) according to their MAC addresses. You can manually add a MAC address to restrict permission to access the ENS Dual Band series. The default setting is:

Disable Wireless MAC Filter.

Note: Only applicable in Access Point and WDS AP modes.

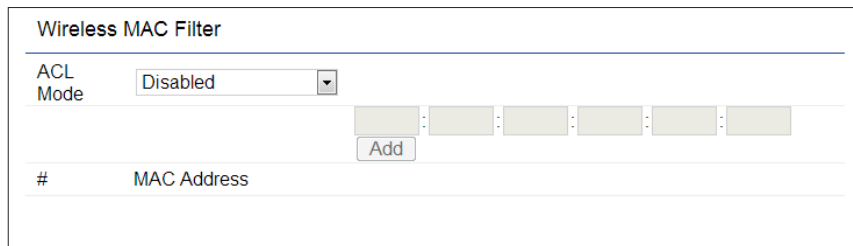

Wireless MAC Filter

ACL Mode: Disabled

MAC Address Input: [] . [] : [] . [] : [] . []

Add

#	MAC Address
---	-------------

ACL Mode: Determines whether network access is granted or denied to clients whose MAC addresses appear in the MAC address table on this page. Your choices are: Disabled, Deny MAC in the list, or Allow MAC in the list.

MAC Address: Enter the MAC address of the wireless client.

Add: Click **Add** to add the MAC address to the MAC address table.

Delete: Delete the selected entries.

Save: Click **Save** to apply the changes.

Wireless Advanced

Wireless Traffic Shaping

Traffic shaping regulates the flow of packets leaving an interface to deliver improved Quality of Service.

Wireless Traffic Shaping		
Enable Traffic Shaping	Disable ▾	
Download Limit	100	Mbps (1-999)
Upload Limit	100	Mbps (1-999)

Enable Traffic Shaping: Check this option to enable Wireless Traffic Shaping.

Download Limit: Specifies the wireless transmission speed used for downloading.

Upload Limit: Specifies the wireless transmission speed used for uploading.

Save: Click **Save** to confirm the changes.

WPA-PSK (WPA Pre-Shared Key) Encryption:

Wireless Security - 2.4G	
Security Mode	WPA2-PSK ▾
Encryption	Both(TKIP+AES) ▾
Passphrase	
Group Key Update Interval	3600

Encryption: Select the WPA encryption type you would like. Please ensure that your wireless clients use the same settings.

Passphrase: Wireless clients must use the same Key to associate the device. If using ASCII format, the Key must be from 8 to 63 characters in length. If using HEX format, the Key must be 64 HEX characters in length.

Group Key Update Interval: Specifies how often, in seconds, the Group Key changes.

WPA Mixed-Enterprise: Access Point / WDS AP mode

Wireless Security - 2.4G	
Security Mode	WPA Mixed-Enterprise ▾
Encryption	Both(TKIP+AES) ▾
Group Key Update Interval	3600
Radius Server	
Radius Port	1812
Radius Secret	
Radius Accounting	Disable ▾
Radius Accounting Server	
Radius Accounting Port	1813
Radius Accounting Secret	
Interim Accounting Interval	600

Encryption: Select the WPA encryption type you would like. Please ensure that your wireless clients use the same settings.

Radius Server: Enter the IP address of the Radius server.

Radius Port: Enter the port number used for connections to the Radius server.

Radius Secret: Enter the secret required to connect to the Radius server.

Group Key Update Interval: Specifies how often, in seconds, the Group Key changes.

Radius Accounting: Enable or disable accounting feature.

Radius Accounting Server: Enter the IP address of the Radius accounting server.

Radius Accounting Port Enter the port number used for connections to the Radius accounting server.

Radius Accounting Secret: Enter the secret required to connect to the Radius accounting server.

Interim Accounting Interval: Specifies how often, in seconds, the accounting data sends.

Note: 802.11n does not allow WEP/WPA-PSK TKIP/WPA2-PSK TKIP security mode. The connection mode will automatically change from 802.11n to 802.11g.

Fast Roaming

Enable the function to serve mobile client devices that roam from Access Point to Access Point. Some applications running on Client devices require fast re-association when they roam to a different Access Point

Please enter the settings of the SSID and initialize the Security mode to WPA enterprise, as well as to set the Radius Server firstly. Users can enable the Fast Roaming and implement the advanced search.

Please also set the same enterprise Encryption under the same SSID on other Access Points and enable the Fast Roaming. When the configuration is realized on different Access Point, the mobile client devices can run the voice service and require seamless roaming to prevent delay in conversation from Access Point to Access Point.

Fast Roaming	
Enable Fast Roaming	Enable ▾
Advanced Search	Enable ▾

Enable Fast Roaming: Enable or disable fast roaming feature.

Enable Advanced Search: Enable or disable advanced search feature.

WDS Link Settings

Using the WDS (Wireless Distribution System) feature will allow a network administrator or installer to connect to Access Points wirelessly. Doing so will extend the wired infrastructure to locations where cabling is not possible or inefficient to implement.

Note: Compatibility between different brands and models of Access Points is not guaranteed. It is recommended that the WDS network be created using the same models for maximum compatibility.

Also note: All Access Points in the WDS network need to use the same Channel and Security settings.

To create a WDS network, please enter the MAC addresses of the Access Points that you want included in the WDS. There can be a maximum of four Access Points.

Note: Only applicable in WDS AP and WDS Bridge modes.

2.4 GHz/5 GHz WDS Link Settings

WDS Link Settings - 2.4GHz			
Security	None ▾		
AES Passphrase	<input type="text"/> (8-63 ASCII characters or 64 hexadecimal digits)		
ID	MAC Address		Mode
1	<input type="text"/>	<input type="text"/>	Disable ▾
2	<input type="text"/>	<input type="text"/>	Disable ▾
3	<input type="text"/>	<input type="text"/>	Disable ▾
4	<input type="text"/>	<input type="text"/>	Disable ▾

WDS Link Settings - 5GHz			
Security	None ▾		
AES Passphrase	<input type="text"/> (8-63 ASCII characters or 64 hexadecimal digits)		
ID	MAC Address		Mode
1	<input type="text"/>	<input type="text"/>	Disable ▾
2	<input type="text"/>	<input type="text"/>	Disable ▾
3	<input type="text"/>	<input type="text"/>	Disable ▾
4	<input type="text"/>	<input type="text"/>	Disable ▾

Security: Select **None** or **AES** from the drop-down list.

AES Passphrase: Enter the Key Values you wish to use. Other Access Points must use the same Key to establish a WDS link.

MAC Address: Enter the Access Point's MAC address to where you want to extend the wireless area.

Mode: Select to disable or enable from the drop-down list.

Save: Click **Save** to confirm the changes.

Guest Network Settings

Adding a guest network allows visitors to use the Internet without giving out your office or company wireless security key. You can add a guest network to each wireless network in the 2.4 GHzb/g/n and 5 GHza/n frequencies.

Guest Network Settings					
Enable	SSID	Edit	Security	Suppressed SSID	Station Separation
<input type="checkbox"/>	EnGenius-2.4GHz_GuestNet	<input type="button" value="Edit"/>	None	<input type="checkbox"/>	<input checked="" type="checkbox"/>
<input type="checkbox"/>	EnGenius-5GHz_GuestNet	<input type="button" value="Edit"/>	None	<input type="checkbox"/>	<input checked="" type="checkbox"/>
Manual IP Settings					
- IP Address	<input type="text" value="192.168.200.1"/>				
- Subnet Mask	<input type="text" value="255.255.255.0"/>				
Automatic DHCP Server Settings					
- Starting IP Address	<input type="text" value="192.168.200.100"/>				
- Ending IP Address	<input type="text" value="192.168.200.200"/>				
- WINS Server IP	<input type="text" value="0.0.0.0"/>				

SSID: Specifies the SSID for the current profile.

Suppressed SSID: Check this option to hide the SSID from clients. If checked, the SSID will not appear in the site survey.

Station Separation: Click the appropriate radio button to allow or prevent communication between client devices.

IP Address: The IP Address of this device.

Subnet Mask: The IP Subnet mask of this device.

Starting IP Address: The first IP Address in the range of the addresses by the DHCP server.

Ending IP Address: The last IP Address in the range of addresses assigned by the DHCP server.

Fast Handover

Fast Handover	
Fast Handover	<input type="button" value="Enable"/> ▾
RSSI	<input type="text" value="-70"/> RSSI(Range: -60 ~ -90)

Fast Handover: Enable the Fast Handover feature by ensuring that each client is served by at least one Access Point at any time. Access Points continuously monitor the connectivity quality of any client in their range and efficiently share this information with other Access Points in the vicinity of that client to coordinate which of them should serve the client best.

RSSI: Enter the RSSI (Received Signal Strength Index) in order to determine the handover procedure which the current wireless link will terminate. RSSI is an indication of the power level being received by the antenna. Therefore, the higher the RSSI number, the stronger the signal.

Chapter 8

Management



Management VLAN Settings

This page allows you to assign a VLAN tag to packets sent over the network. A VLAN is a group of computers on a network whose software has been configured so that they behave as if they were on a separate Local Area Network (LAN). Computers on VLAN do not have to be physically located next to one another on the LAN.

Note: Only applicable in Access Point and WDS AP modes.

Management VLAN Settings	
CAUTION: If you reconfigure the Management VLAN ID, you may lose connectivity to the access point. Verify that the switch and DHCP server can support the reconfigured VLAN ID, and then re-connect to the new IP address.	
Management VLAN	Enable <input checked="" type="checkbox"/> 4096

Management VLAN: If your network includes VLANs, you can enable **Management VLAN ID** for packets passing through the Access Point with a tag.

Save: Click **Save** to confirm the changes or **Cancel** to cancel and return to previous settings.

Note: If you reconfigure the Management VLAN ID, you may lose your connection to the ENS Dual Band series. Verify that the DHCP server supports the reconfigured VLAN ID and then reconnect to the ENS Dual Band series using the new IP address.

Advanced Settings

SNMP Settings

This page allows you to assign the Contact Details, Location, Community Name, and Trap Settings for a Simple Network Management Protocol (SNMP). SNMP is a networking management protocol used to monitor network attached devices. SNMP allows messages (called protocol data units) to be sent to various parts of the network. Upon receiving these messages, SNMP compatible devices (called agents) returns the data stored in their Management Information Bases.

SNMP Settings	
Status	Enable
Contact	
Location	
Port	161
Community Name (Read Only)	public
Community Name (Read Write)	private
Trap Destination	
- Port	162
- IP Address	
- Community Name	public
SNMPv3 Settings	
- Status	Enable
- Username	admin (1-31 Characters)
- Authorized Protocol	MD5
- Authorized Key	12345678 (8-32 Characters)
- Private Protocol	DES
- Private Key	12345678 (8-32 Characters)
- Engine ID	

SNMP Enable/Disable: Enables or disables the SNMP feature.

Contact: Specifies the contact details of the device.

Location: Specifies the location of the device.

Community Name (Read Only): Specifies the password for the SNMP community for read only access.

Community Name (Read/Write): Specifies the password for the SNMP community with read/write access.

Trap Destination Address: Specifies the IP address of the computer that will receive the SNMP traps.

Trap Destination Community Name: Specifies the password for the SNMP trap community.

SNMPv3: Enables or disables the SNMPv3 feature.

User Name: Specifies the username for SNMPv3.

Auth Protocol: Selects the authentication protocol type: MDS or SHA.

Auth Key: Specifies the authentication key.

Priv Protocol: Selects the privacy protocol type: DES.

Priv Key: Specifies the privacy key for privacy.

Engine ID: Specifies the engine ID for SNMPv3.

Apply Save: Click **Apply Save** to apply the changes.

CLI Settings

CLI Setting	
CLI	Enable ▾
SSH Setting	
SSH	Disable ▾
HTTPS Setting	
HTTPS	Enable ▾
HTTPS forward	Disable ▾

CLI: The Command Line Interface (CLI) allows you to type commands instead of choosing them from a menu or selecting an icon.

SSH: Enable Secure Shell (SSH) to make secure, encrypted connections in the network. Secure Shell is a network protocol that allows data to be exchanged using a secure channel between two network devices.

HTTPS: Enable HTTPS to transfer and display web content securely. The Hypertext Transfer Protocol over SSL (Secure Socket Layer) is a TCP/IP protocol used by web servers to transfer and display web content securely.

Email Alert

You can use the Email Alert feature to send messages to the configured email address when particular system events occur.

Note: Do **NOT** use your personal email address as it can unnecessarily expose your personal email login credentials. Use a separate email account made for this feature instead

Email Alert	
Status	<input checked="" type="checkbox"/> Enable
- From	<input type="text"/>
- To	<input type="text"/>
- Subject	[Email-Alert][ENH900EXT][00.02.6F.FF.FF] Config
Email Account	
- Username	<input type="text"/>
- Password	<input type="text"/>
- SMTP Server	<input type="text"/> Port: 25
- Security Mode	None ▾ <input type="button" value="Send Test Mail"/>

From: Enter the email address to show the sender of the email.

To: Enter the address to receive email alerts.

Subject: Enter the text to appear in the email subject line.

Username: Enter the username for the email account that will be used to send emails.

Password: Enter the password for the email account that will be used to send emails.

SMTP Server: Enter the IP address or hostname of the outgoing SMTP server.

Port: Enter the SMTP port number to use for outbound emails.

Time Zone

Time Setting

This page allows you to set the internal clock of the ENS Dual Band series.

Date and Time Settings

Manually Set Date and Time

Date: 2013 / 09 / 25

Time: 08 : 10 (24-Hour)

Automatically Get Date and Time

NTP Server: 209.81.9.7

Time Zone

Time Zone: UTC+00:00 Gambia, Liberia, Morocco

Enable Daylight Saving

Start: January 1st Sun 12 am

End: January 1st Mon 12 am

Start: Select the day, month, and time when daylight savings time starts.

End: Select the day, month, and time when daylight savings times ends.

Manually Set Date and Time: Manually specify the date and time.

Automatically Get Date and Time: Select **Automatically Get Date and Time** and check whether you wish to enter the IP address of an NTP server or use the default NTP server to have the internal clock set automatically.

Enable Daylight Saving: Check whether daylight savings applies to your area.

Auto Reboot Settings

You can specify how often you wish to reboot the ENS Dual Band series.

Auto Reboot Setting	
Auto Reboot Status	Disable ▾
Timer	<input type="checkbox"/> Sunday <input type="checkbox"/> Monday <input type="checkbox"/> Tuesday <input type="checkbox"/> Wednesday <input type="checkbox"/> Thursday <input type="checkbox"/> Friday <input type="checkbox"/> Saturday
	0 : 0

Auto Reboot Setting: Enables or disables the Auto Reboot function.

Frequency of Auto Reboot: Specifies how often you wish to reboot the ENS Dual Band series by Min, Hour, Day or Week.

Timer: Select the day and enter the time you would like to reboot automatically.

Save: Click **Save** to apply the changes.

Wi-Fi Scheduler

The Wi-Fi Scheduler can be created for use in enforcing rules. For example, if you wish to restrict web access to Mon-Fri from 3pm to 8pm, you could create a schedule selecting Mon, Tue, Wed, Thu and Fri while entering a Start time of 3pm and End Time of 8pm to limit access to these times.

Wi-Fi Scheduler																																																																						
Status	Enable <input type="checkbox"/>																																																																					
	NOTE: Please assure that the Time Zone Settings is synced with your local time when enabling the Wi-Fi Scheduler.																																																																					
Wireless Radio	2.4GHz <input type="checkbox"/>																																																																					
SSID Selection	EnGenius063C96_1-2.4GHz <input type="checkbox"/>																																																																					
Schedule Templates	Choose a template <input type="checkbox"/>																																																																					
Schedule Table	<table border="1"><thead><tr><th>Day</th><th>Availability</th><th colspan="4">Duration</th></tr></thead><tbody><tr><td>Sunday</td><td>available <input type="checkbox"/></td><td>00</td><td>:</td><td>00</td><td>~</td><td>24</td><td>:</td><td>00</td></tr><tr><td>Monday</td><td>available <input type="checkbox"/></td><td>00</td><td>:</td><td>00</td><td>~</td><td>24</td><td>:</td><td>00</td></tr><tr><td>Tuesday</td><td>available <input type="checkbox"/></td><td>00</td><td>:</td><td>00</td><td>~</td><td>24</td><td>:</td><td>00</td></tr><tr><td>Wednesday</td><td>available <input type="checkbox"/></td><td>00</td><td>:</td><td>00</td><td>~</td><td>24</td><td>:</td><td>00</td></tr><tr><td>Thursday</td><td>available <input type="checkbox"/></td><td>00</td><td>:</td><td>00</td><td>~</td><td>24</td><td>:</td><td>00</td></tr><tr><td>Friday</td><td>available <input type="checkbox"/></td><td>00</td><td>:</td><td>00</td><td>~</td><td>24</td><td>:</td><td>00</td></tr><tr><td>Saturday</td><td>available <input type="checkbox"/></td><td>00</td><td>:</td><td>00</td><td>~</td><td>24</td><td>:</td><td>00</td></tr></tbody></table>	Day	Availability	Duration				Sunday	available <input type="checkbox"/>	00	:	00	~	24	:	00	Monday	available <input type="checkbox"/>	00	:	00	~	24	:	00	Tuesday	available <input type="checkbox"/>	00	:	00	~	24	:	00	Wednesday	available <input type="checkbox"/>	00	:	00	~	24	:	00	Thursday	available <input type="checkbox"/>	00	:	00	~	24	:	00	Friday	available <input type="checkbox"/>	00	:	00	~	24	:	00	Saturday	available <input type="checkbox"/>	00	:	00	~	24	:	00
	Day	Availability	Duration																																																																			
	Sunday	available <input type="checkbox"/>	00	:	00	~	24	:	00																																																													
	Monday	available <input type="checkbox"/>	00	:	00	~	24	:	00																																																													
	Tuesday	available <input type="checkbox"/>	00	:	00	~	24	:	00																																																													
	Wednesday	available <input type="checkbox"/>	00	:	00	~	24	:	00																																																													
	Thursday	available <input type="checkbox"/>	00	:	00	~	24	:	00																																																													
	Friday	available <input type="checkbox"/>	00	:	00	~	24	:	00																																																													
Saturday	available <input type="checkbox"/>	00	:	00	~	24	:	00																																																														

Status: Enables or disables the Wi-Fi scheduler function.

Wireless Radio: Select 2.4 GHz or 5 GHz from the drop-down list for the preferred band type.

SSID Selection: Select a SSID from the drop-down list.

Schedule Templates: Select a schedule template from the drop-down list.

Day(s): Place a checkmark in the boxes for the desired days or select the **All Week** radio button to select all seven days of the week.

Duration: The Start Time is entered in two fields. The first box is for hours and the second box is for minutes. The End Time is entered in the same format as the Start time.

Tools

Ping Test Parameters

This page allows you to analyze the connection quality of the ENS Dual Band series and trace the routing table to a target in the network.

Ping Test Parameters	
Target IP / Domain Name	<input type="text"/>
Ping Packet Size	<input type="text" value="64"/> Bytes
Number of Pings	<input type="text" value="4"/>
<input type="button" value="Start"/>	<div style="border: 1px solid #ccc; height: 100px;"></div>

Traceroute Test Parameters	
Target IP / Domain Name	<input type="text"/>
<input type="button" value="Start"/> <input type="button" value="Stop"/>	<div style="border: 1px solid #ccc; height: 100px;"></div>

Target IP: Enter the IP address you would like to search.

Ping Packet Size: Enter the packet size of each ping.

Number of Pings: Enter the number of times you wish to ping.

Start Ping: Click **Start Ping** to begin pinging the target device (via IP).

Traceroute Target: Enter the IP address or domain name you wish to trace.

Start Traceroute: Click **Start Traceroute** to begin the trace route operation.

Speed Test Parameters / LED Control

This page allows you to control LED on/off for Power, LAN interface, or 2.4 GHz/5 GHz WLAN interface.

Speed Test Parameters		
Target IP / Domain Name	<input type="text"/>	
Time Period	<input type="text" value="20"/>	sec
Check Interval	<input type="text" value="5"/>	sec
<input type="button" value="Start"/>		
<div style="border: 1px solid gray; height: 100px; width: 100%;"></div>		
IPv4 Port	<input type="text" value="5001"/>	
IPv6 Port	<input type="text" value="5002"/>	

LED Control	
Power	<input type="button" value="Enable"/>
LAN	<input type="button" value="Enable"/>
WLAN-2.4GHz	<input type="button" value="Enable"/>
WLAN-5GHz	<input type="button" value="Enable"/>
<input type="button" value="Apply"/> Apply saved settings to take effect	

LED Control

Power: Enables or disables the Power LED indicator.

LAN: Enables or disables the LAN LED indicator.

WLAN-2.4 GHz: Enables or disables the WLAN-2.4 GHz LED indicator.

WLAN-5 GHz: Enables or disables the WLAN-5 GHz LED indicator.

Device Discovery

This page allows you to discover devices from network for Operation Mode, IP Address, System MAC Address and Firmware version.

Device Discovery				
Device Name	Operation Mode	IP Address	System MAC Address	Firmware Version
<input type="button" value="Scan"/>				

Account

This page allows you to change the ENS Dual Band series username and password. By default, the username is: **admin** and the password is: **admin**. The password can contain from 0 to 12 alphanumeric characters and is case sensitive.

Account Settings

Account Settings	
Administrator Username	admin
Current Password	•••••
New Password	
Verify Password	

Administrator Username: Enter a new username for logging in to the New Name entry box.

Current Password: Enter the old password for logging in to the Old Password entry box.

New Password: Enter the new password for logging in to the New Password entry box.

Verify Password: Re-enter the new password in the Confirm Password entry box for confirmation.

Apply: Click **Apply** to apply the changes.

Firmware

Firmware Upgrade

This page allows you to upgrade the firmware of the



The screenshot shows a web interface titled "Firmware Upgrade". It displays "Current Firmware Version: 2.0.0" and a prompt to "Select the new firmware from your hard disk." Below this is a file selection area with a "Browse..." button and the text "No file selected." An "Upload" button is also visible.

To Perform the Firmware Upgrade:

1. Click the **Choose File** button and navigate the OS file system to the location of the upgrade file.
2. Select the upgrade file. The name of the file will appear in the Upgrade File field.
3. Click the **Upload** button to commence the firmware upgrade.

Note: The device is unavailable during the Firmware upgrade process and must restart when the upgrade is completed. Any connections to or through the device will be lost.

Backup/Restore

This page allows you to save the current device configurations. When you save your configurations, you also can reload the saved configurations into the device through the Restore Saved Settings from a file section. If extreme problems occur, or if you have set the ENS Dual Band series incorrectly, you can use the **Reset** button in the Revert to Factory Default Settings section to restore all the configurations of the ENS Dual Band series to the original default settings.

Backup Setting: Click **Export** to save the current configured settings.

Restore New Setting: To restore settings that have been previously backed up, click **Browse**, select the file, and click **Restore**.

Restore to Default: Click **Reset** button to restore the ENS Dual Band series to its factory default settings.

Backup/Restore Settings	
Factory Setting	
- Backup Setting	<input type="button" value="Export"/>
- Restore New Setting	<input type="button" value="Browse..."/> No file selected. <input type="button" value="Import"/>
- Reset to Default	<input type="button" value="Reset"/>
User Setting	
- Back Up Setting as Default	<input type="button" value="Backup"/>
- Restore to User Default	<input type="button" value="Restore"/>

User Setting

The function allows you to backup the current device configurations into the ENS Dual Band series as the default value. If extreme problems occur, or if you have set the ENS Dual Band series incorrectly, you can push the Reset button to revert all the configurations of the ENS Dual Band series to the user default.

Back Up Setting as Default: Click **Backup** to backup the user settings you would like to the device's memory for the default settings.

Restore to User Default: Click **Restore** to restore user settings to the factory standard settings.

Note1: After setting the current settings as the default, you should click the **Restore to Default** on the web interface for reverting the settings into the factory default instead of pushing the reset button.

Note2: Please **write down** your account and password before saving. The user settings will now become the new default settings at the next successful login.

Log

System Log

The ENS Dual Band series automatically logs (records) events of possible interest in its internal memory. To view the logged information, click the **Log** link under the System Manager menu. If there is not enough internal memory to log all events, older events are deleted from the log. When powered down or rebooted, the log will be cleared.

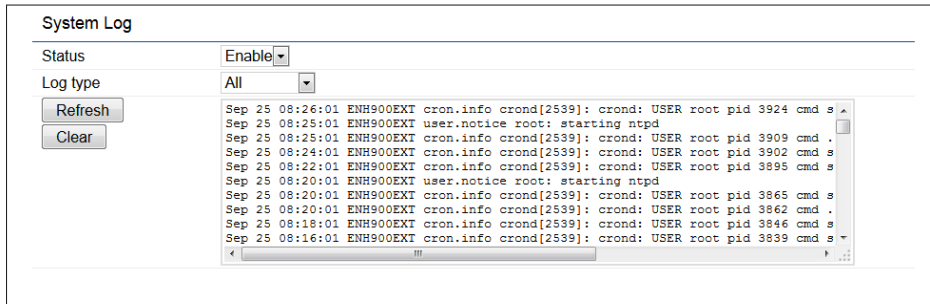

Remote Log

This page allows you to setup the Remote Log functions for the ENS Dual Band series.

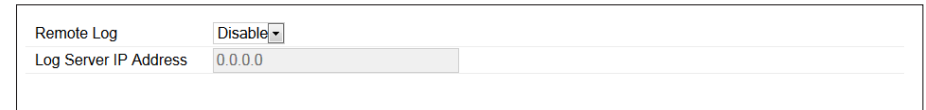

Syslog: Enables or disables the syslog function.

Log Server IP Address: Enter the IP address of the log server.

Remote Log: Enable or disable the remote log service.

Apply: Click **Apply** to apply the changes.

Logout

Click **Logout** in Management menu to logout.

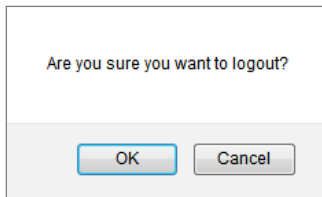
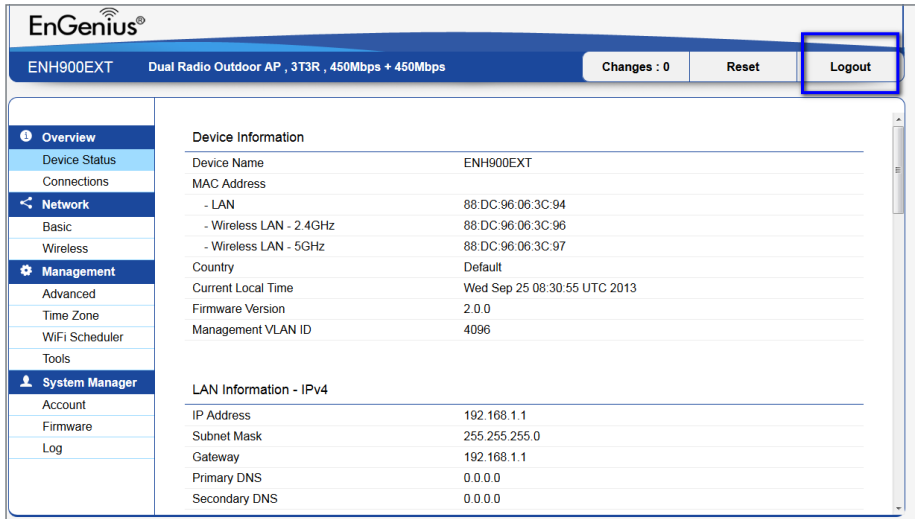

Reset

In some circumstances, it may be required to force the device to reboot. Click on **Reset** to reboot the ENS Dual Band series.

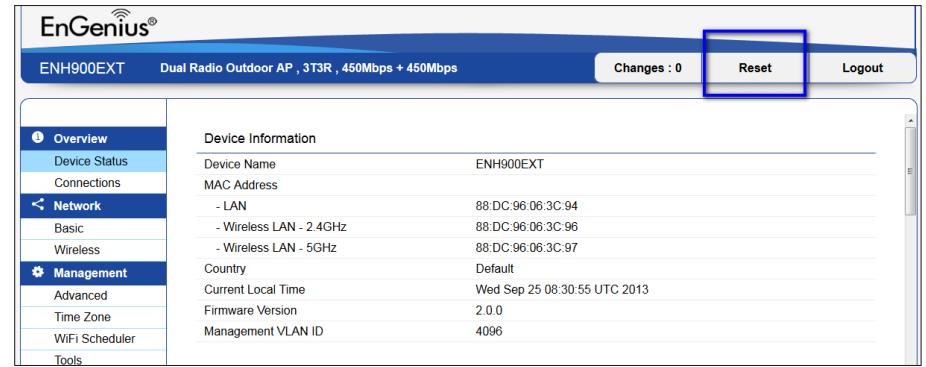

Appendix



Appendix A

Federal Communication Commission Interference Statement

This equipment has been tested and found to comply with the limits for a Class B digital device, pursuant to Part 15 of the FCC Rules. These limits are designed to provide reasonable protection against harmful interference in a residential installation. This equipment generates, uses and can radiate radio frequency energy and, if not installed and used in accordance with the instructions, may cause harmful interference to radio communications. However, there is no guarantee that interference will not occur in a particular installation. If this equipment does cause harmful interference to radio or television reception, which can be determined by turning the equipment off and on, the user is encouraged to try to correct the interference by one of the following measures:

- Reorient or relocate the receiving antenna.
- Increase the separation between the equipment and receiver.
- Connect the equipment into an outlet on a circuit different from that to which the receiver is connected.
- Consult the dealer or an experienced radio/TV technician for help



FCC Caution:

Any changes or modifications not expressly approved by the party responsible for compliance could void the user's authority to operate this equipment.

This device complies with Part 15 of the FCC Rules. Operation is subject to the following two conditions: (1) This device may not cause harmful interference, and (2) this device must accept any interference received, including interference that may cause undesired operation.

IMPORTANT NOTE:

Radiation Exposure Statement

This equipment complies with FCC radiation exposure limits set forth for an uncontrolled environment. This equipment should be installed and operated with minimum distance 29 cm between the radiator & your body.

Appendix B - CE Interference Statement

Europe - EU Declaration of Conformity

This device complies with the essential requirements of the R&TTE Directive 1999/5/EC. The following test methods have been applied in order to prove presumption of conformity with the essential requirements of the R&TTE Directive 1999/5/EC:

- **EN60950-1**
Safety of Information Technology Equipment
- **EN50385**
Generic standard to demonstrate the compliance of electronic and electrical apparatus with the basic restrictions related to human exposure to electromagnetic fields (0 Hz - 300 GHz)
- **EN 300 328**
Electromagnetic compatibility and Radio spectrum Matters (ERM); Wideband Transmission systems; Data transmission equipment operating in the 2,4 GHz ISM band and using spread spectrum modulation techniques; Harmonized EN covering essential requirements under article 3.2 of the R&TTE Directive
- **EN 301 893**
Broadband Radio Access Networks (BRAN); 5 GHz high performance RLAN; Harmonized EN covering essential requirements of article 3.2 of the R&TTE Directive
- **EN 301 489-1**
Electromagnetic compatibility and Radio Spectrum Matters (ERM); ElectroMagnetic Compatibility (EMC) standard for radio equipment and services; Part 1: Common technical requirements
- **EN 301 489-17**
Electromagnetic compatibility and Radio spectrum Matters (ERM); ElectroMagnetic Compatibility (EMC) standard for radio equipment and services; Part 17: Specific conditions for 2,4 GHz wideband transmission systems and 5 GHz high performance RLAN equipment

This device is a 5GHz wideband transmission system (transceiver), intended for use in all EU member states and EFTA countries, except in France and Italy where restrictive use applies.

In Italy the end-user should apply for a license at the national spectrum authorities in order to obtain authorization to use the device for setting up outdoor radio links and/or for supplying public access to telecommunications and/or network services.

This device may not be used for setting up outdoor radio links in France and in some areas the RF output power may be limited to 10 mW EIRP in the frequency range of 2454 – 2483.5 MHz. For detailed information the end-user should contact the national spectrum authority in France.

CE 0560

Česky [Czech]	[Jméno výrobce] tímto prohlašuje, že tento [typ zařízení] je ve shodě se základními požadavky a dalšími příslušnými ustanoveními směrnice 1999/5/ES.
Dansk [Danish]	Undertegnede [fabrikantens navn] erklærer herved, at følgende udstyr [udstyrets typebetegnelse] overholder de væsentlige krav og øvrige relevante krav i direktiv 1999/5/EF.
Deutsch [German]	Hiermit erkläre [Name des Herstellers], dass sich das Gerät [Gerätetyp] in Übereinstimmung mit den grundlegenden Anforderungen und den übrigen einschlägigen Bestimmungen der Richtlinie 1999/5/EG befindet.
Eesti [Estonian]	Käesolevaga kinnitab [tootja nimi = name of manufacturer] seadme [seadme tüüp = type of equipment] vastavust direktiivi 1999/5/EÜ põhinõuetele ja nimetatud direktiivist tulenevatele teistele asjakohastele sätetele.
English	Hereby, [name of manufacturer], declares that this [type of equipment] is in compliance with the essential requirements and other relevant provisions of Directive 1999/5/EC.
Español [Spanish]	Por medio de la presente [nombre del fabricante] declara que el [clase de equipo] cumple con los requisitos esenciales y cualesquiera otras disposiciones aplicables o exigibles de la Directiva 1999/5/CE.
Ελληνική [Greek]	ΜΕ ΤΗΝ ΠΑΡΟΥΣΑ [name of manufacturer] ΔΗΛΩΝΕΙ ΟΤΙ [type of equipment] ΣΥΜΜΟΡΦΩΝΕΤΑΙ ΠΡΟΣ ΤΙΣ ΟΥΣΙΩΔΕΙΣ ΑΠΑΙΤΗΣΕΙΣ ΚΑΙ ΤΙΣ ΛΟΙΠΕΣ ΣΧΕΤΙΚΕΣ ΔΙΑΤΑΞΕΙΣ ΤΗΣ ΟΔΗΓΙΑΣ 1999/5/ΕΚ.

Français [French]	Par la présente [nom du fabricant] déclare que l'appareil [type d'appareil] est conforme aux exigences essentielles et aux autres dispositions pertinentes de la directive 1999/5/CE.
Italiano [Italian]	Con la presente [nome del costruttore] dichiara che questo [tipo di apparecchio] è conforme ai requisiti essenziali ed alle altre disposizioni pertinenti stabilite dalla direttiva 1999/5/CE.
Latviski [Latvian]	Ar šo [name of manufacturer / izgatavotāja nosaukums] deklarē, ka [type of equipment / iekārtas tips] atbilst Direktīvas 1999/ 5/EK būtiskajām prasībām un citiem ar to saistītajiem noteikumiem.
Lietuvių [Lithuanian]	Šiuo [manufacturer name] deklaruoją, kad šis [equipment type] atitinka esminius reikalavimus ir kitas 1999/5/EB Direktyvos nuostatas.
Nederlands [Dutch]	Hierbij verklaart [naam van de fabrikant] dat het toestel [type van toestel] in overeenstemming is met de essentiële eisen en de andere relevante bepalingen van richtlijn 1999/5/EG.
Malti [Maltese]	Hawnhekk, [isem tal-manifattur], jiddikjara li dan [il-mudal tal-prodott] jikkonforma mal-ħtiġijiet essenzjali u ma provvedimenti oħrajn relevanti li hemm fid-Dirrettiva 1999/5/EC.
Magyar [Hungarian]	Alulírott, [gyártó neve] nyilatkozom, hogy a [... típus] megfelel a vonatkozó alapvető követelményeknek és az 1999/5/EC irányelv egyéb előírásainak.
Polski [Polish]	Niniejszym [nazwa producenta] oświadczam, że [nazwa wyrobu] jest zgodny z zasadniczymi wymogami oraz pozostałymi stosownymi postanowieniami Dyrektywy 1999/5/EC.
Português [Portuguese]	[Nome do fabricante] declara que este [tipo de equipamento] está conforme com os requisitos essenciais e outras disposições da Directiva 1999/5/CE.
Slovensko [Slovenian]	[Ime proizvajalca] izjavlja, da je ta [tip opreme] v skladu z bistvenimi zahtevami in ostalimi relevantnimi določili direktive 1999/5/ES.
Slovensky [Slovak]	[Meno výrobcu] týmto vyhlasuje, že [typ zariadenia] spĺňa základné požiadavky a všetky príslušné ustanovenia Smernice 1999/5/ES.
Suomi [Finnish]	[Valmistaja = manufacturer] vakuuttaa täten että [type of equipment = laitteen tyyppimerkintä] tyyppinen laite on direktiivin 1999/5/EY oleellisten vaatimusten ja sitä koskevien direktiivin muiden ehtojen mukainen.
Svenska [Swedish]	Härmed intygar [företag] att denna [utrustningstyp] står i överensstämmelse med de väsentliga egenskapskrav och övriga relevanta bestämmelser som framgår av direktiv 1999/5/EG.

Appendix C - IC Interference Statement

Industry Canada statement

This device complies with RSS-210 of the Industry Canada Rules. Operation is subject to the following two conditions: (1) This device may not cause harmful interference, and (2) this device must accept any interference received, including interference that may cause undesired operation.

Ce dispositif est conforme à la norme CNR-210 d'Industrie Canada applicable aux appareils radio exempts de licence. Son fonctionnement est sujet aux deux conditions suivantes: (1) le dispositif ne doit pas produire de brouillage préjudiciable, et (2) ce dispositif doit accepter tout brouillage reçu, y compris un brouillage susceptible de provoquer un fonctionnement indésirable.



IC Caution:

High-power radars are allocated as primary users (i.e. priority users) of the bands 5250-5350 MHz and 5650-5850 MHz and that these radars could cause interference and/or damage to LE-LAN devices.



Avertissement:

(De plus, les utilisateurs devraient aussi être avisés que les utilisateurs de radars de haute puissance sont désignés utilisateurs principaux (c.-à-d., qu'ils ont la priorité) pour les bandes 5250-5350 MHz et 5650-5850 MHz et que ces radars pourraient causer du brouillage et/ou des dommages aux dispositifs LAN-EL.

IMPORTANT NOTE:

Radiation Exposure Statement

This equipment complies with IC radiation exposure limits set forth for an uncontrolled environment. This equipment should be installed and operated with minimum distance 29cm between the radiator & your body.

Déclaration d'exposition aux radiations

Cet équipement est conforme aux limites d'exposition aux rayonnements IC établies pour un environnement non contrôlé. Cet équipement doit être installé et utilisé avec un minimum de 29cm de distance entre la source de rayonnement et votre corps.