



Fiber Amplifier

**FOACAMPC1 Series**

**User's manual**

Thank you for choosing L-com. Please read the manual carefully before using this product.

- The product should be applied by someone with a certain level of electrical knowledge.
- Please read and make sure that you understand how to operate the product before using it.
- Please keep this manual readily accessible for future reference when needed.

**Warning**

Please comply with the warnings indicated below for they are important.

	Please do not exceed maximum rated voltage during usage in order to prevent tester malfunction or fire.
	Please do not apply AC power supply to avoid breakage.
	Please do not subject the product to high temperature to avoid scalding.

**Safety precautions**

It is dangerous to wire or attach/remove the connector with the power on. Make sure to turn off the power before operation.

Make sure to use the product with the protective cover attached and closed.

Installing in the following places may result in malfunction:

1. A dusty or steamy place.
2. A place generating corrosive gas.
3. A place directly receiving scattering water or oil.
4. A place suffered from heavy vibration or impact.

The product is not designed for outdoor use.

Do not use the sensor in transient state after power on (approx. 300ms).

Do not wire with the high voltage cable or the power line.

Failure to do this will cause malfunction by induction or damage.

The sensor performance or digital display values may depend on the individual units or the condition of detected product.

This product is not an explosion-proof construction.

Do not use the product under flammable, explosive gas or liquid environment.

Do not use the product in water.

Do not disassemble, repair, or convert the product.

Failure to do this may cause failure, fire, or electric shock.

Operate within the rated range.

**What is inside**

- 1 PCS Amplifier
- 1 PCS Manual
- 1 PCS Fiber clip

**Dimensions**

Unit:mm

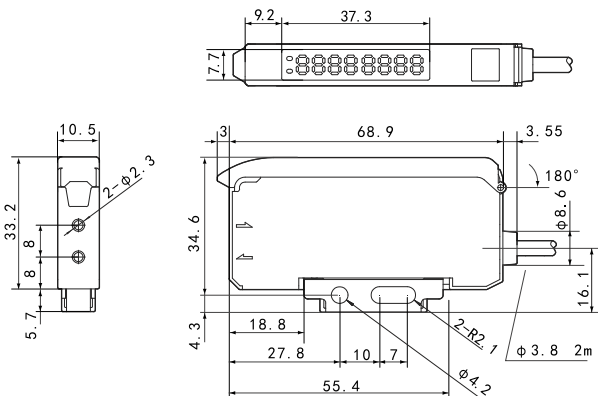

**Specification**

Power source, voltage	12-24VDC±10%including a ripple	
Power consumption	Normal	1 output : 864mW max.(36mA or less / 24V) 2 output : 936mW max.(39mA or less / 24V)
	Eco All	1 output : 600mW max.(25mA or less / 24V) 2 output : 672mW max.(28mA or less / 24V)
Response Time	1-HS: 16μs (no interconnection), 22us (interconnected) / 2-FS: 70us (no interconnection), 85us (interconnected) 3-ST: 250μs / 4-LG: 500μs / 5-PL: 1ms / 6-UL: 2ms / 7-EL: 8ms	
Control output	1 output / 2 output, NPN / PNP Open collector 100mA / 30V or less Load current : 100mA or less, Residual voltage : 1.8V or less	
Output method	Light on / Dark on Switching type in the function	
Short-circuit protection	Incorporated	
Light source	Red LED (632nm)	
Indicator light / Display	1 output	Output Indicator light : Orange (Ch 1) / 7 segment 8 digit display
	2 output	Output Indicator light : Orange (Ch 1 / Ch 2) / 7 segment 8 digit display
Sensitivity setting	Teaching / Manual adjustment	
Timer function	OFF: On delay timer, Off delay timer, One-shot timer, On delay-off delay timer, On delay-one shot timer	
Timer time	0.1ms~9.999s	
External input setting	Teach-in, Emitter stop, Synchronous, Counter reset (only for 2 output type)	
Output setting	1 output	Output 1
	2 output	Output 2
Number of cross talk prevention	1-HS: 2units/ 2-FS: 3-ST: 4units/ 4-LG: 5-PL: 8units/ 6-UL: 7-EL: 12units *1	
Operating temperature /humidity	-25~+55°C/35~85%RH (No freezing and No condensation) *2	
Store temperature /humidity	-30~+70°C/35~85%RH (No freezing and No condensation)	
Shock resistance	10~55Hz Amplitude 1.5mm 2 hours for each direction of X, Y, and Z	
Protective category	IP50	
Protective category	PC : Cover, Case	
Weight	Cable type : 71g (including cordes)	

\*1 These mean maximum number of units can be prevented cross talk. Response Time of every unit must be set same mode.  
\*2 Temp./Maximum units interconnect: -25°C~55°C/ 3 units (output current: 100mA max.),  
-25°C~50°C/ 8 units (output current: 50mA max.), -25°C~45°C/16 units (output current: 20mA max.)

**Circuit**

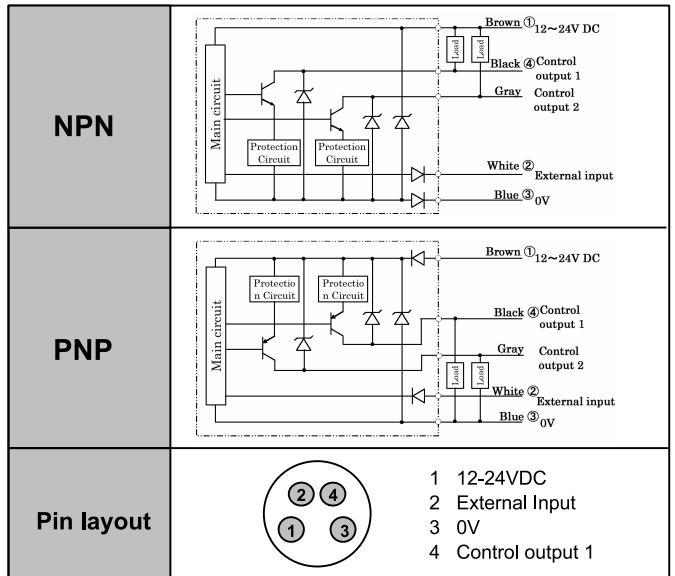

- \* Slave unit doesn't have the power supply cables (Brown and Blue).
- \* Gray line (Control output 2) is only for the 2 output type (D3RF-TDM/S)

**Display/Indicator/Buttons**

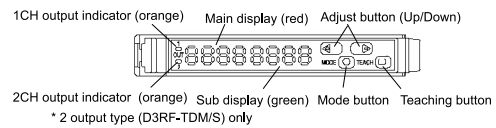

**Installing Amplifier**

**Mounting and Removing to/from DIN rail**

**Mounting of Amplifier Unit**

Hook the claw on the connecting side of fiber cable to the DIN rail, Then press down the hook until it locks.

**Removing of Amplifier Unit**

Pushing the unit to the direction of A, hold up the connecting side of fiber cable and remove the unit.

**How to Connect the fiber cables**

- Open fiber lock lever.
- Insert fiber into holes to stop.
- Return fiber lock lever until it stops.

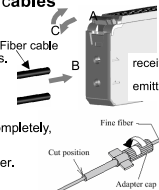

**CAUTION**

With Coaxial reflection fiber, set single core fiber or white-lined fiber to the emitter. Then set Multi core fiber to the receiver.

**How to use Fine fiber**

- Turn adapter cap anticlockwise completely, then appropriately insert the fiber.
- Cut the excess fiber with fiber cutter.

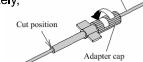

**Interconnection**

Mount each sensor on DIN rail and slide to interconnect one by one. Mount the End Plates at both ends.  
\* Up to 16 units can be interconnected.

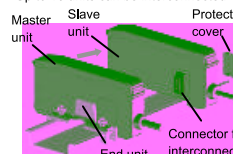

**Note**

Confirm that Power supply is OFF while Installation. Use DIN rail and End Plates for installation. Confirm that environmental temperature is in specification. (refer a note \*2 at "Specifications") Install the protective cover at the end connector of slave unit. Don't remove sensors from DIN rail while it's interconnected. Remove the End plates, slide the sensor and remove one by one from DIN rail.

## Display and Buttons

### Switching display

Display shows as follows according to its mode

Operating (RUN mode)	Setup	Teaching
It shows as example when it's actually detecting object. It goes to this mode after power up Ex.) <b>200 100</b> Sensing Threshold level	It switches to this Setup mode by pressing "MODE" button over 3 seconds. Ex.) <b>L--d L on</b> Function Setup Value	It switches to this Teaching mode by pressing "TEACH" button over 3 seconds. Ex.) <b>2Pt 1Pt</b> Mode of teaching

### Buttons

Buttons work as follows according to its mode

Buttons	Operating (RUN mode)	Setup / Teaching
	Adjust (+ UP)	Change the Setup function and mode of Teaching
	Adjust (- DOWN)	
	Switch to Setup mode	Set the setup
	Switch to Teaching mode	Execute Teaching

## Setup menu

### Basic menu

These are basic menu that to be setup before using.  
Please refer Expert menu for further setup function.

Display	Menu	Function
<b>L--d</b>	Output mode	Switch Light ON and Dark ON
<b>rESP</b>	Response speed	Set response speed
<b>dELy</b>	Timer/Delay	Set Timer and Delay
<b>Eprt</b>	Expert mode	Enter to Expert mode (refer Expert menu)
<b>rSet</b>	Initialize	Initialize setup to default
<b>End</b>	Exit	Exit setup mode

### Expert menu

These are menu for function that setup in detail.  
Expert menu is available from "Eprt" in Basic menu.

Display	Menu	Function
<b>0rSt</b>	Zero reset	Set main display to 0 (zero).
<b>diSP</b>	Display mode	Set display mode for operating (RUN mode)
<b>Eco</b>	Eco mode	Set Eco mode
<b>turn</b>	Rotation	Rotate the display 180 degree
<b>HyS</b>	Hysteresis	Specify hysteresis percentage
<b>PrCS</b>	Detection mode	Set detection mode (edge/level)
<b>cnt</b>	Counter	Switch ON/OFF Counter and specify UP/DOWN direction
<b>InPt</b>	External input	Set function of external input
<b>coPy</b>	Copy setup	Copy setup to sensors interconnected
<b>AL 0</b>	All Zero Clear/Reset	Set all display of sensors interconnected to Zero "0"
<b>Atch</b>	All Teaching	Execute Teaching on every sensor interconnected
<b>ASc</b>	ASC	Set ON/OFF ASC (Automatic Sensitivity Control)
<b>Spor</b>	Emitter Power	Specify Emitter power
<b>LocL</b>	Lock level	Specify level of Key Lock
<b>SAuE</b>	Save	Save the current setup
<b>End EPrt</b>	Exit	Exit expert menu
<b>Loc</b>	Lock	Lock buttons (refer useful function)

### Teaching menu

Threshold level can be set by these menu.  
Please refer "Teaching".

Display	Menu	Function
<b>2Pt</b>	2 Point Teaching	Set the threshold at the center between with object and without object.
<b>1Pt</b>	1 Point Teaching	Set the threshold at minimum level that can detect object stably with.
<b>thru</b>	Through Teaching	Set the threshold at around 90% of sensing level without object for through beam application.
<b>ZonE</b>	Zone Teaching	Set the threshold at around sensing level $\pm 10\%$ .
<b>Auto</b>	Automatic Teaching	Set the threshold at the center between maximum and minimum level.
<b>P-t</b>	Percent Teaching	Threshold can be set any percentage.
<b>0P-t</b>	Zero % Teaching	Set the threshold at any percentage and execute zero reset.
<b>End tEch</b>	End of Teaching	Exit Teaching mode.

## Basic setup

Press "MODE" button over 3 sec.

Choose the setup value by and . Define the setup by and go back to top of each menu. "+" is default value.

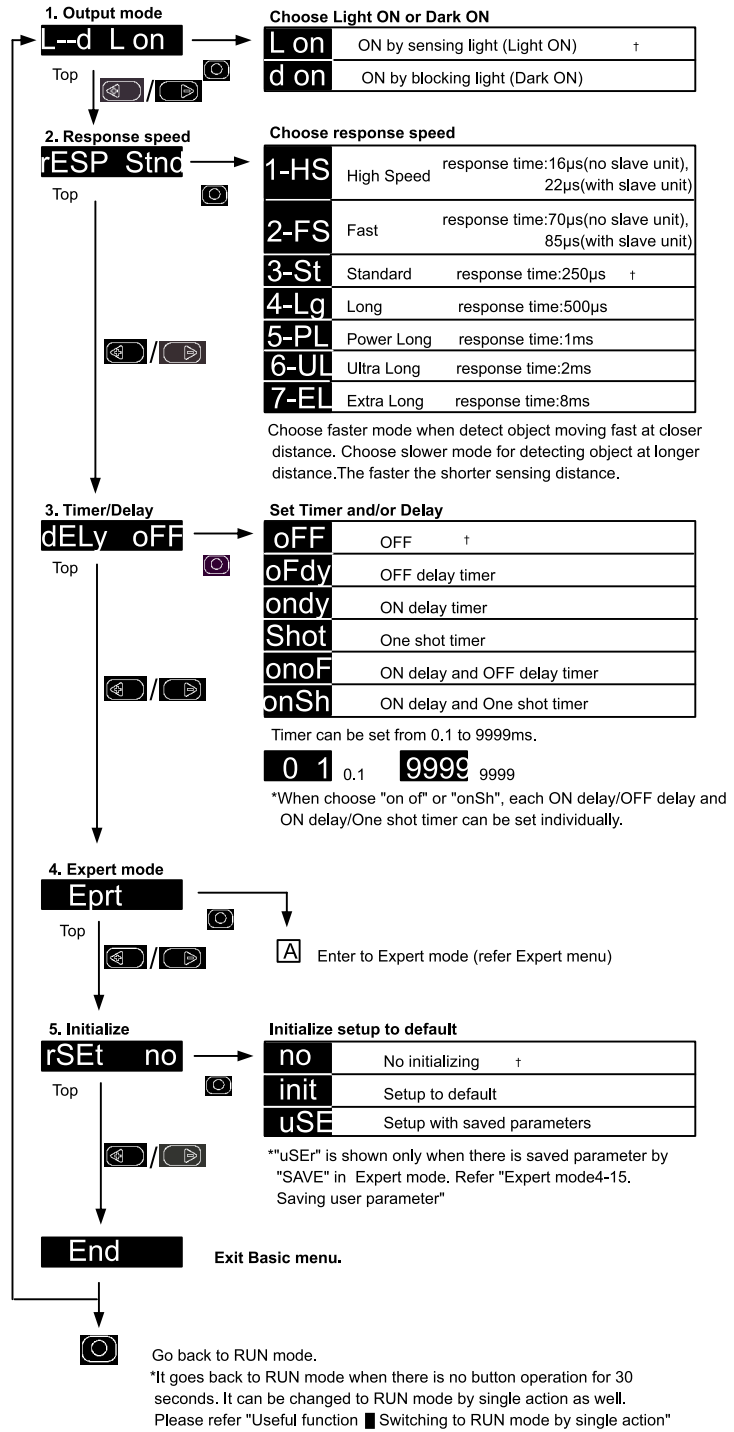

## Setup Threshold manually

At RUN mode, press or then, threshold display blinks that shows it can be adjusted. Adjust the threshold by or . You can adjust upper and lower threshold when it's Zone Teaching mode.

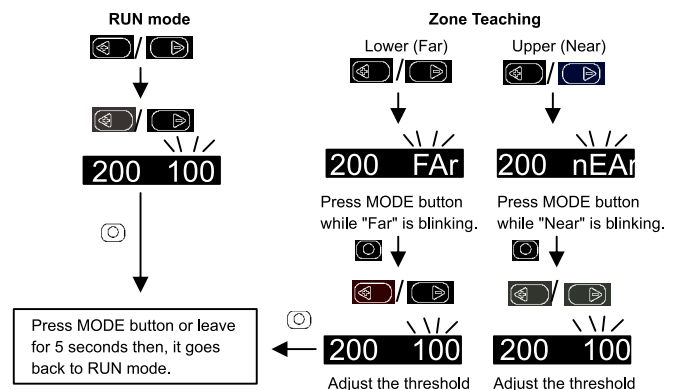

# Teaching

Press TEACH button for 3 seconds.

Choose Teaching mode by pressing or . Then, press to confirm. When Teaching is done, it goes back to RUN mode after the threshold blinks. You can refer current sensing level by pressing MODE while teaching.

## 1. 2 point Teaching

2Pt 1Pt

Top  
Threshold is set at center of 1st and 2nd level.  
Teach twice with object and without object.

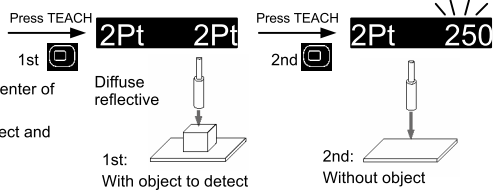

## 2. 1 point Teaching (1)

1Pt

Top  
Threshold is set at minimum level that enable stable detection.  
Good for long distance

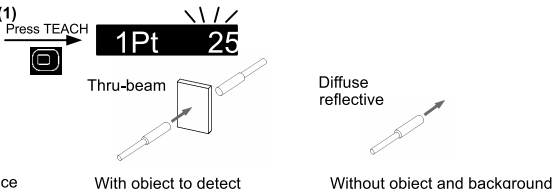

## 3. 1 point Teaching (2)

1Pt

Top  
Teaching with only background for diffuse reflective mode. Threshold is set at minimum level that enable stable detection.

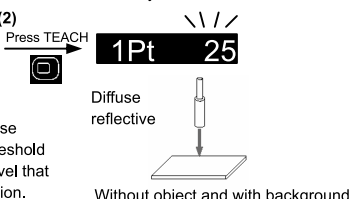

## 4. Through Teaching

thru

Top  
Threshold is set at around 90% of sensing level.  
Good for detecting transparent object like Glass and Film.

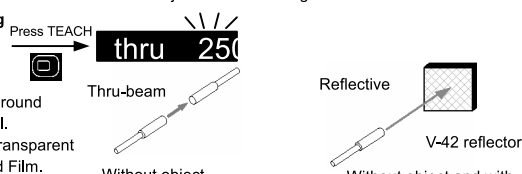

## 5. Zone Teaching

Zone

Top  
Threshold is set at around sensing level  $\pm 10\%$ .  
Good for detecting object in the area specified.

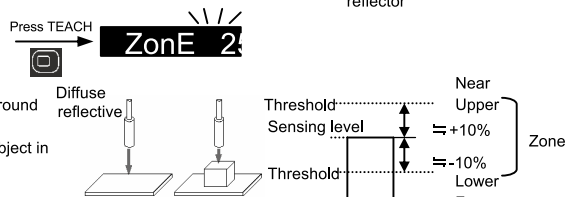

Teaching to be done with object or with only background.  
\*When Zone teaching is done with only background, threshold level will be set at around  $\pm 10\%$  from the background.

## 6. Automatic Teaching

Auto Strt

Top  
Threshold is set at the center between maximum and minimum level. Good for teaching without stopping production line.

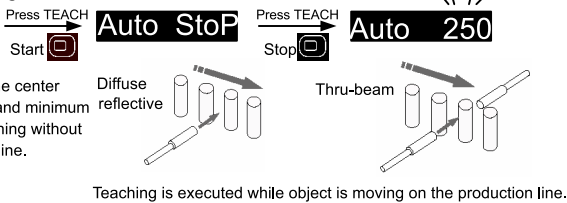

## 7. Percent Teaching

P-t 90

Top  
You can set threshold at any percentage adjusted.  
By setting sensing level without object that block the beam as 100%, it can detect the level as relative percentage level.  
Re-Teaching can be done by single button action while RUN mode. Refer "Useful function" "Fitting in".

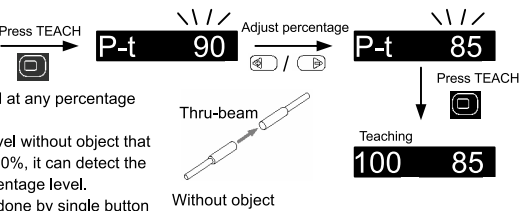

## 8. Zero percent Teaching

OP-t 10

Top  
Set any percentage adjusted to 0% as threshold.  
For diffuse reflective mode, set the sensing level with only background 0% and detect the level as relative percentage level.  
Re-Teaching can be done by single button action while RUN mode. Refer "Useful function" "Fitting in".

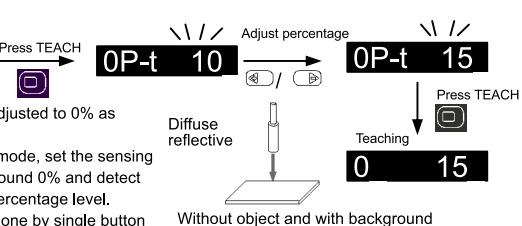

## End tEch

Exit the Teaching mode  
By pressing TEACH button, it goes back to RUN mode.

# Expert mode

Setup parameters for further function.

From [A] "Basic menu"

Choose the setup value by and . Define the setup by and go back to top of each menu. "+" is default value.

## 4-1. Zero reset

OrSt oFF

### Set main display to 0 (zero)

oFF No action †  
on Reset the main display

Reset the sensing level shown on the main display to zero and shift the threshold shown on the sub display as much as the main display shifted. This function is not active when percent mode and edge detection mode.

## 4-2. Display mode

diSP dig

### Choose display mode from following three

dig Digital mode † Ex.) 200 22  
Sensing level Threshold

bAr Bar display mode Ex.)   
Bar increases according to sensing level from right

Pct Percent mode Ex.) 100 110  
"\_" means it's percentage Sensing level Threshold  
100% 110%

## 4-3. Eco mode

Eco oF

### Set Eco mode

oFF No action †

diSP Power off sub display (green) and darken main display (red).  
This will work 20 seconds after the setup.  
Double emitting cycle.  
Actual response time will be doubled as well.

ALL Power off sub display, darken main display and double emitting cycle. Actual response time will be doubled as well. Brightness of the display will be changed 20 seconds after the setup.

Current consumption of "Eco ALL" will be 30% less than "Eco oFF".

## 4-4. Rotation

turn oFF

### Rotate the display 180 degree

oFF No action † Ex.) turn oFF

on Rotate the display Ex.)

This is effective when you have to mount the sensor opposite direction.

## 4-5. Hysteresis

HvS P

### Set Hysteresis percentage

P 5 † Set from 1% to 40%

P 1 ~ P 40  
1% 40%

Set the hysteresis according to the condition. When it's unstable because of chattering, set bigger percentage. When to detect slight difference, set smaller percentage.

## 4-6. Detection mode

PrcS Stn

### Set Detection mode

Stnd Detect by sensing level †

nd % Detect UP edge

hd7 Detect Down edge

diFF Differential mode

### Set filter level for edge detection

FiLt 1000 1,000 Hz † Faster

FiLt 200 200 Hz

FiLt 50 50 Hz

FiLt 20 20 Hz

FiLt 5 5 Hz Slower

speed of edge detection

### Edge detection mode:

Detect changes of sensing level in a certain period.  
"Detect UP edge" : Detect the sensing level increasing  
"Detect Down edge" : Detect the sensing level decreasing  
\*Only Automatic Teaching can be executed when edge detection is activated.

\*Percent display mode is unavailable when edge detection is activated.

\* Only CH1 can be set Edge detection for the 2 output type (D3RF-TDM/S).

\*Hysteresis will be fixed to 1% when Edge detection is active.

\*Edge detection won't work correctly when the sensing level is saturated or there is no light received.

\*Filter to be "Slower" to detect sensing level that swings slower.

### Differential mode:

It detects difference of sensing level from the sensor unit next to it at master side. The display shows "1024" when sensing levels are same. When the sensing level is smaller than the sensor unit at master side, the display shows smaller value than "1024". When its bigger, the display shows bigger value than "1024".

\* Differential mode is available only for the slave unit (D3RF-TS/TDS).

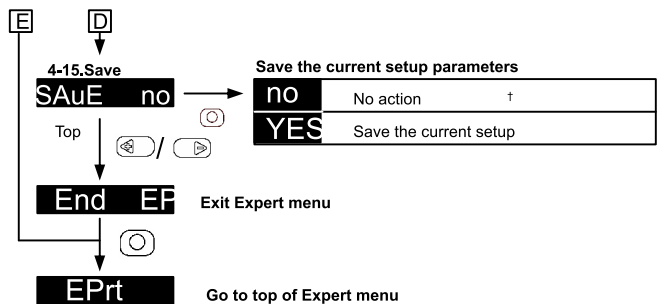
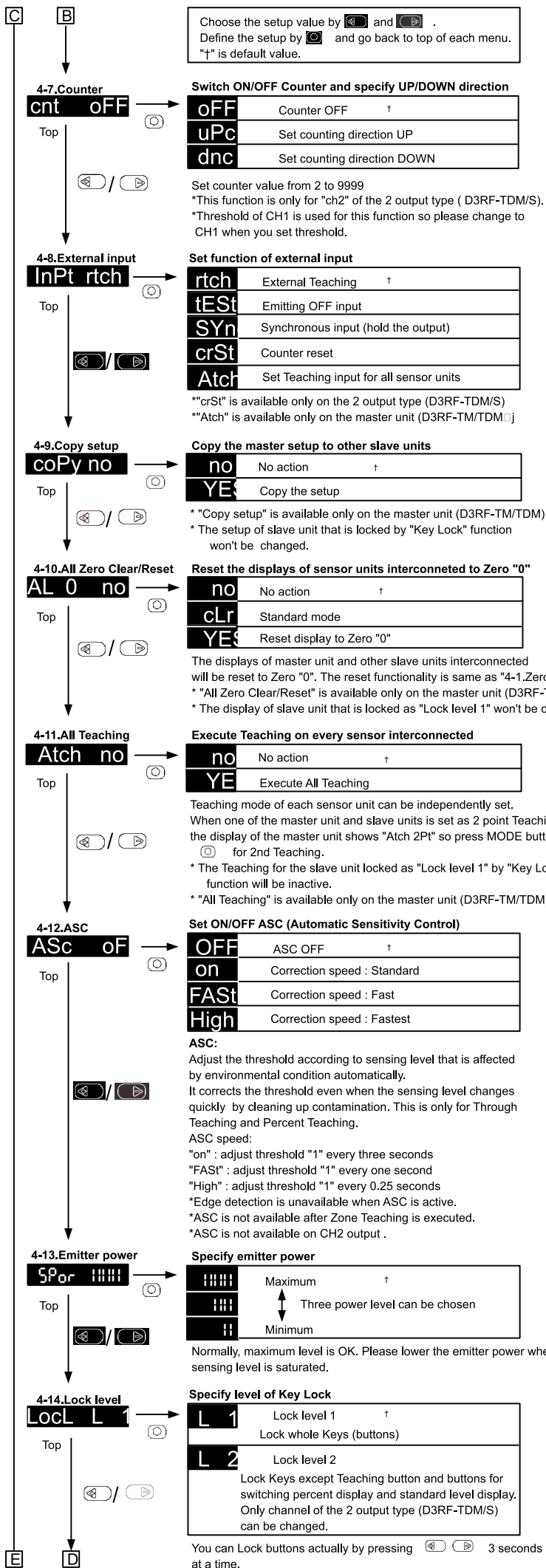

**Note** Some menu won't be shown depends on the setup. It's not a malfunction. Time of pressing buttons to activate not specified on this manual is 0.3 seconds. When the parameter value is ready to set, sub display will blink. Following parameters of the 2 output type (D3RF-TDM/S) can be specified individually for Output 1 (ch1) and Output 2 (ch2). Other parameters are specified commonly. **Threshold, Output mode, Timer and its value, Teaching menu**

**Useful function**

**Switch channel (only for the 2 output type D3RF-TDM/S)**  
Press button then, the channel number will be blinking and switch to the channel.



Threshold of CH2 will be copied to CH1 under following condition after external teaching. This is useful when you want to set single threshold level to both CH1 and CH2.  
- ASC and Edge detection are inactive.  
- Teaching mode of CH1 is same as CH2.  
- Display is showing level of CH2.  
\*You can switch channel from any setup menu.

**Key Lock**

Make the buttons unavailable to prevent operation mistake. Press for 3 seconds to Lock buttons at a time while RUN mode. Do same to cancel it..

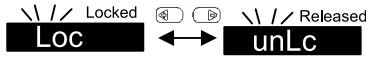

You can choose a Lock level from two in "Expert mode 4-14.Lock level".

**Switching to RUN mode by single action**

By pressing button for 3 seconds in setup menu while sub display is not blinking,

it switches to RUN mode without going through "End".

**Switching to percent display by single action**

Press and buttons at a time then, the display switches to percent display.

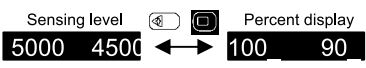

You can setup this function at "Expert mode 4-2.Display mode" as well. Do same to get back to standard display mode.

**Fitting in (set sensing level to "100%"/"0%")**

When "Percent Teaching" or "Zero % Teaching" is chosen in Teaching menu, you can set the sensing level to "100%" or "0%" by pressing and buttons at a time. This is effective when detection get unstable.



**Error**

Following are error messages when error occurred while Teaching. Please try again accordingly.

Err1	Sensing level is not enough
Err2	Sensing level is saturated
Err3	Dif ference of sensing level between two points