

HG2358-18XP-090-2NF MOUNTING BRACKET DIAGRAM

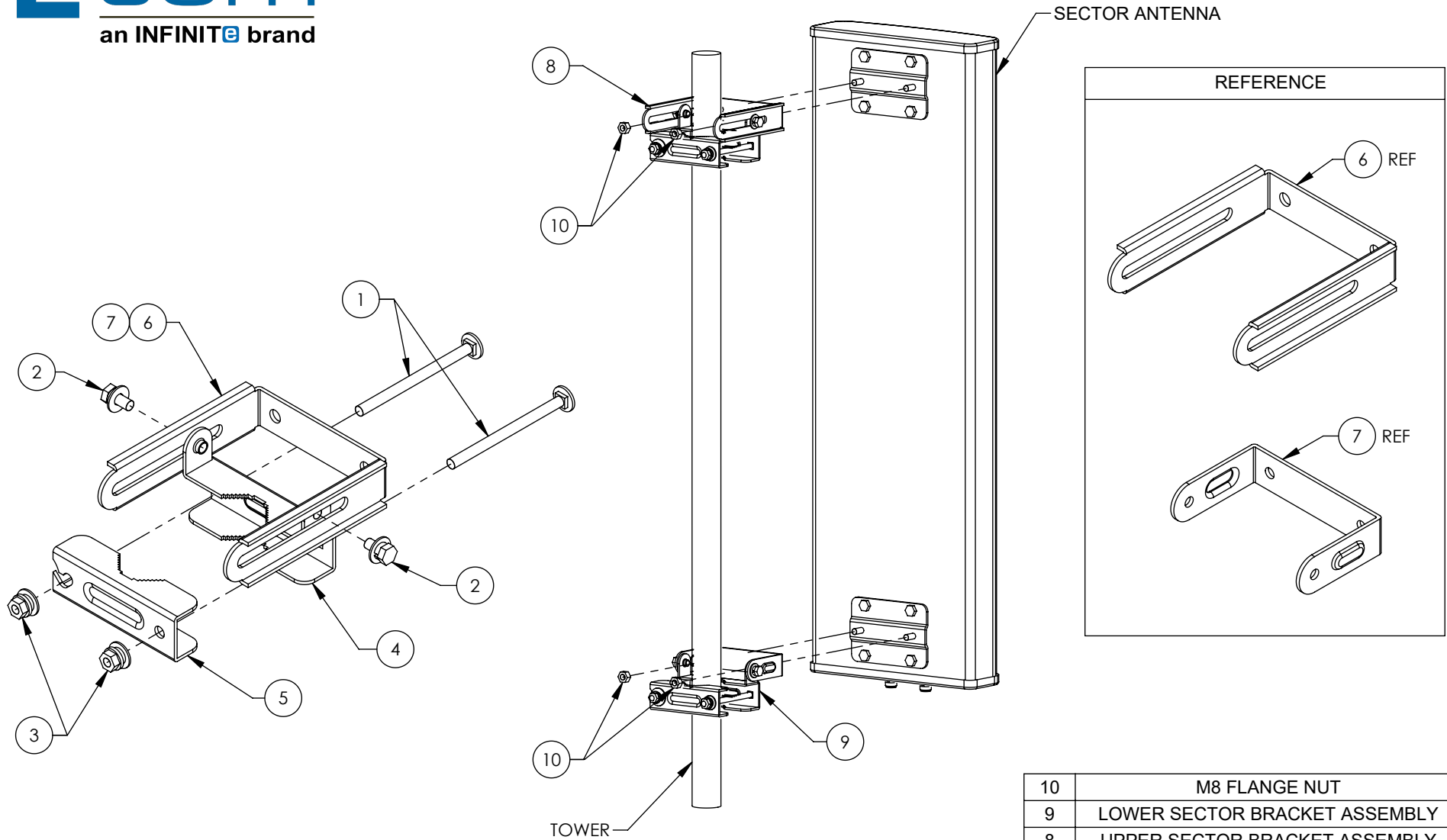

SECTOR BRACKET ASSEMBLY DIAGRAM
UPPER MOUNTING BRACKET (SHOWN) USE ITEM #6
LOWER MOUNTING BRACKET USE ITEM #7

10	M8 FLANGE NUT	4
9	LOWER SECTOR BRACKET ASSEMBLY	1
8	UPPER SECTOR BRACKET ASSEMBLY	1
7	LOWER SECTOR BRACKET	1
6	UPPER SECTOR BRACKET	1
5	C-CLAMP TOWER BRACKET B	1
4	C-CLAMP TOWER BRACKET A	1
3	M8 FLANGE NUT	2
2	M8 X 25mm CARRIAGE BOLT	2
1	M8 X 125mm CARRIAGE BOLT	2
NO.	DESCRIPTION	QTY