

IEEE 802.3at / af Power over Ethernet Injectors

Injecteurs Ethernet la norme IEEE 802.3at / af

IEEE 802.3at / af Strom über Ethernet Injektoren

Power over Ethernet Injectors IEEE 802.3at / af

IEEE 802.3at / af Energia para Inyectores Ethernet

через Power over Ethernet IEEE 802.3at / af Инжекторы

Inyectores IEEE 802.3at / af Energía sobre Ethernet

POE-151 / POE-152 / POE-161

User's Manual

Table of Contents

English

1. Overview	1-1
2. Package Contents.....	1-1
3. Product Outlook	1-2
4. LED Indication	1-2
5. Hardware Installation.....	1-3
6. Product Specification	1-6

Française

1. Vue d'ensemble.....	2-1
2. Contenu du lot.....	2-1
3. Détail du produit.....	2-2
4. Voyant DEL.....	2-2
5. Installation du matériel.....	2-3
6. Caractéristiques du produit.....	2-6

Deutsch

1. Überblick	3-1
2. Packungsinhalt	3-1
3. Produkt Ansicht.....	3-2
4. LED Anzeige	3-2
5. Hardware Installation.....	3-3
6. Produkt Spezifikation	3-6

Italiano

1. Informazioni generali	4-1
2. Contenuto della confezione.....	4-1
3. Vista del Prodotto.....	4-2
4. LED di stato.....	4-2
5. Installazione	4-3
6. Specifiche del Prodotto	4-6

Português

1. Apresentação	5-1
2. Conteúdos da Embalagem.....	5-1
3. Apresentação do Produto	5-2
4. Indicação LED	5-2
5. Instalação do equipamento	5-3
6. Especificação do Produto.....	5-6

Русский

1. Обзор	6-1
2. В комплект входят	6-1
3. Внешний вид продукта.....	6-2
4. Светодиодная индикация.....	6-2
5. Установка оборудования	6-3
6. Характеристики продукта	6-7

Español

1. Información general.....	7-1
2. Contenido del paquete	7-1
3. Vista general del Producto.....	7-2
4. Indicación LED	7-2
5. Instalación del hardware	7-3
6. Especificación de Producto	7-7

1. Overview

Thank you for purchasing PLANET **IEEE 802.3at / af Power over Ethernet Injectors**. These PoE injectors will work with any Power Device (PD) that also supports the IEEE 802.3af / at standards. The models belowned are included:

Model	PoE Standard	Max. PoE Out	Power In	Pass-thru. Speed
POE-151	IEEE 802.3af	15.4 Watts	48V DC	10/100Mbps
POE-152	IEEE 802.3af	15.4 Watts	48V DC	10/100/1000Mbps
POE-161	IEEE 802.3at / af	30 Watts	56V DC	10/100/1000Mbps

Unless specified, terms of **"PoE Injector"** in the following sections means the model listed above.

2. Package Contents

Upon open the box of the PoE Injector and carefully unpack it. The box should contain the following items:

POE-151 / POE-152	POE-161
<ul style="list-style-type: none"> ● The 802.3af PoE Injector x 1 ● User's Manual x 1 ● DC 48V Power Adapter x 1 	<ul style="list-style-type: none"> ● The 802.3at High Power over Ethernet Injector x 1 ● User's Manual x 1 ● DC 56V Power Adapter x 1 ● Power Cord x 1



Note

If any of these pieces are missing or damaged, please contact your dealer immediately. If possible, retain the carton including the original packing material, and use them again to repack the product in case of a need to return for repair.

3. Product Outlook

POE-151 / POE-152

There are two RJ-45 Twisted-Pair jack, one DC 48V Power socket and two LED indicators.

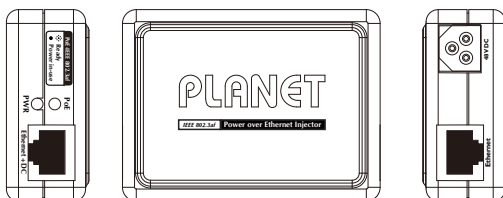

Figure 1: POE-151 / POE-152

POE-161

There are two RJ-45 Twisted-Pair jack, one DC 56V Power socket and two LED indicators.

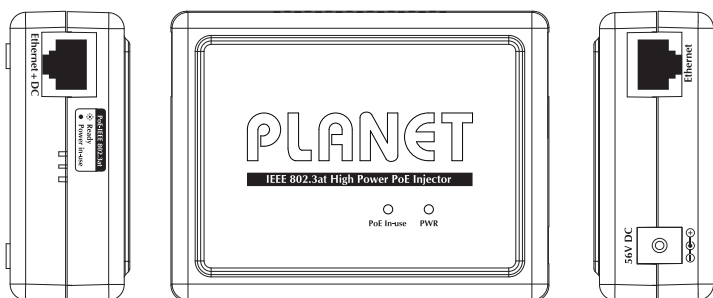

Figure 2: POE-161 Overview

4. LED Indication

LED	Description
Power	Lights to indicate that the PoE Injector has power from AC-DC adapter.
PoE In-use	Lights to indicate the PoE Injector is providing DC in-line power.

5. Hardware Installation

This section describes the hardware features of **PoE Injector**. Before connecting any network device to the **PoE Injector**, refer to this chapter carefully.

5.1 Before Installation

Before your installation, it is recommended to check your network environment. The PLANET **PoE Injector** is with an AC-DC adapter and inject the DC power into the pin of the twisted pair cable follow the IEEE standard, the power and pin assignment relationship is the table below:

Model	Required AC-DC adapter Spec.	PoE Pin Assignment
POE-151	Input: 100~240V AC	4/5(+), 7/8(-)
POE-152	Output: 48V DC	1/2(+), 3/6(-)
POE-161	Input: 100~240C AC Output: 56V DC	4/5(+), 7/8(-)

Category 5/5e/6 UTP/STP cable that with 8-wire are required for the installation. UTP cable with 4-wire (pin 1/2, 3/6) can not work with POE-151/161 and only can work with POE-152 in 10/100Base-TX Ethernet.



Note

PLANET **PoE Injector** and PLANET **PoE Splitter** (ex. POE-151S, POE-152S and POE-162S) can be installed in pair. Use of third-party device is allowed if the device complied with IEEE 802.3at or IEEE 802.3af standard.

5.2 PoE Injector Installation

1. Connect a standard network cable from Switch/workstation to **"Ethernet"** port of **PoE Injector**.
2. Connect the long cable that will be used to connect to the remote device to the port **"Ethernet+DC"**.
3. Connect the AC adapter to **"DC 48V"** of POE-151/POE-152. The power LED will be steady on. Connect the AC adapter to **"DC 56V"** of POE-161. The power LED will be steady on.

4. Connect with IEEE 802.3af devices. Base on IEEE 802.3af standard, the POE-151/POE-152 can directly connect with any IEEE 802.3af end-nodes like wireless access point, VoIP phones and IP camera that support IEEE 802.3af Power over Ethernet interface.

 **Note** For POE-161, base on IEEE 802.3at standard, the POE-161 can directly connect with any IEEE 802.3at end-nodes such as PTZ (Pan, Tilt & Zoom) IP camera, Speed Dome, high power consumption wireless LAN access point that support IEEE 802.3at Power over Ethernet port.

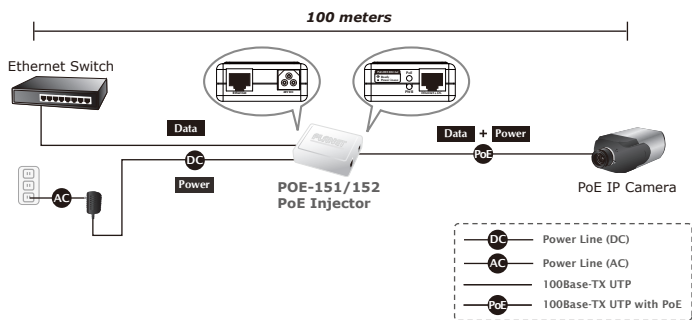



Figure 3: Connection to IEEE 802.3af Device

5. Once POE-151/POE-152 detects the existence of an IEEE 802.3af device, the LED indicator will be steady ON to show it is providing power. The same to POE-161 that detects the existence of an IEEE 802.3at / af device.

 **Note** If the connected device is not fully complying with IEEE 802.3af standard, the LED indicator of POE-151/POE-152 will not be steady on.

 **Note**

1. Since the POE-161 PoE port supports 56V DC PoE power output, please check and assure the Powered Device (PD) acceptable DC power range is from 52 to 56V DC. Otherwise, it will damage the Powered Device (PD).
2. If the connected device is not fully complying with IEEE 802.3at / af Power over Ethernet, the LED indicator of POE-161 will not be steady on.

5.3 PoE Injector and PoE Splitter Installation

For non PoE remote device or Ethernet equipment, the **PoE Injector** and **PoE Splitter** can runs in pair to provide DC Power for those devices, the table below shows the model of PLANET **PoE Splitters**:

Model	PoE Standard	DC Power Out	Pass-thru. Speed
POE-151S	IEEE 802.3af	5V / 12V DC	10/100Mbps
POE-152S	IEEE 802.3af	5V / 12V DC	10/100/1000Mbps
POE-162S	IEEE 802.3at	12V / 24V DC	10/100/1000Mbps

1. Follow step 1, step 2 and step 3 of Section 5.2 for the connection.
2. Connect the UTP cable in the package from **"Ethernet"** of the **PoE splitter** to the RJ-45 port of remote device.
3. Connect proper DC plug from **"DC OUT"** of PoE Splitter to the remote device.

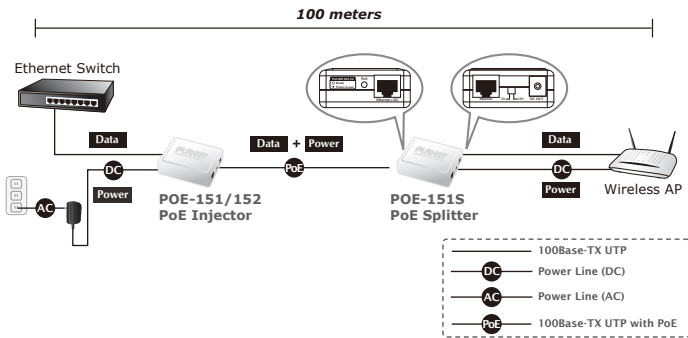

Figure 4: Connection Architecture via PoE Injector and PoE Splitter



Note

Please ensure the PoE Splitter output voltage is correct before applying power to remote device otherwise, it may damage the remote device.

6. Product Specification

Product		POE-151	POE-152	POE-161
Hardware Specification				
Interface	"Data" Input Port	1 x RJ-45 STP		
	"PoE (Data+Power)" Output Port	1 x RJ-45 STP		
	DC Input power socket	1 x 48V DC		1 x 56V DC
LED Indicator		System: Power x 1 (Yellow) PoE Port: PoE in Use x 1 (Green)		System: Power x 1 (Green) PoE Port: PoE in Use x 1 (Green)
Network Cable		UTP Cat. 5/5e/6, up to 100m (328ft)		
Data Rate		10/100Mbps	10/100/1000Mbps	10/100/1000Mbps
Dimension (W x D x H)		73 x 55 x 24 mm	73 x 55 x 24 mm	95 x 70 x 25 mm
Weight		50g	50g	83g
Unit Input Voltage		DC 48V, 0.4A	DC 48V, 0.4A	DC 56V, 0.53A
Power Requirement		100-240V AC, 50/60Hz		
Power Consumption		15.4 Watts max.	15.4 Watts max.	30 Watts max.
Power over Ethernet				
PoE Standard		IEEE 802.3af Power over Ethernet / PSE		IEEE 802.3at / af Power over Ethernet / PSE
PoE Power Output		DC 48V / 15.4 Watts		DC 56V / 30 Watts
PoE Power supply Type		Mid-Span	End-Span	Mid-Span
Power Pin Assignment		4/5(+), 7/8(-)	1/2(+), 3/6(-)	4/5(+), 7/8(-)
Standards Conformance				
IEEE 802.3 10Base-T Ethernet		■	■	■
IEEE 802.3u 100Base-TX Fast Ethernet		■	■	■
IEEE 802.3ab 1000Base-T Gigabit Ethernet		-	■	■
IEEE 802.3af Power over Ethernet		■	■	■
IEEE 802.3at Power over Ethernet		-	-	■
Regulation Compliance		FCC Class B, CE mark	FCC Class B, CE mark	FCC Class A, CE mark
Environment				
Operating Temperature		0 ~ 50 Degree C		
Storage Temperature		-10 ~ 70 Degree C		
Humidity		5 ~ 90% (Non-condensing)		

1. Vue d'ensemble

Merci d'avoir acheté les Injecteurs Ethernet PLANET conformes à la norme **IEEE 802.3at / af**. Ces injecteurs PoE fonctionnent avec n'importe quel Appareil électrique (AE) capable de supporter la norme IEEE 802.3af / at. Les modèles ci-dessous sont inclus:

Modèle	Norme PoE	Sortie PoE max.	Alimentation en cours	Vitesse de transfert
POE-151	IEEE 802.3af	15.4 Watts	48V DC	10/100Mbps
POE-152	IEEE 802.3af	15.4 Watts	48V DC	10/100/1000Mbps
POE-161	IEEE 802.3at / af	30 Watts	56V DC	10/100/1000Mbps

Sauf indication, les termes **"PoE Injecteur"** employés dans les rubriques suivantes font référence aux modèles répertoriés ci-dessus.

2. Contenu du lot

Upon open the box of the PoE Injector and carefully unpack it. The box should contain the following items:

POE-151 / POE-152	POE-161
<ul style="list-style-type: none"> ● 1 Injecteur Ethernet 802.3af ● 1 manuel d'utilisation ● Chargeur 48V CC x 1 	<ul style="list-style-type: none"> ● 1 Injecteur Ethernet 802.3at conforme à la norme IEEE ● 1 manuel d'utilisation ● Chargeur 56V CC x 1 ● Cordon d'alimentation x 1



Remarque

Si l'un de ces éléments manque ou est endommagé, contactez immédiatement votre fournisseur. Si possible, conservez le carton d'origine avec les pièces livrées et renvoyez-le en l'état à l'équipe technique.

3. Détail du produit

POE-151 / POE-152

Il existe deux paires de câbles torsadés RJ-45, Une prise électrique 48V CC et deux voyants DEL.



Schéma 1: POE-151 / POE-152

POE-161

Il existe deux paires de câbles torsadés RJ-45, une prise 56V et deux voyants DEL.

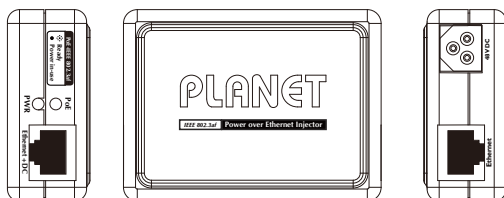

Schéma 2: POE-161 vue d'ensemble

4. Voyant DEL

DEL	Description
Power	S'allume pour indiquer que l' Injecteur PoE est alimenté depuis un chargeur CA-CC.
PoE en cours	S'allume pour indiquer que l' Injecteur PoE alimente la ligne électrique CC.

5. Installation du matériel

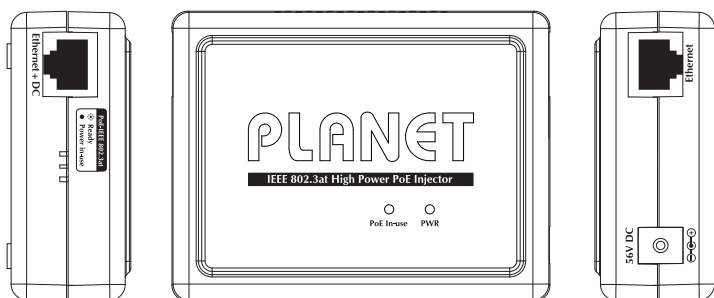
Cette section décrit les fonctions du **Injecteur PoE**. Avant de connecter n'importe quel système réseau au **Injecteur PoE**, consultez ce chapitre.

5.1 Before Installation

Avant de procéder à l'installation, nous vous conseillons de vérifier votre connexion réseau. L'**Injecteur PoE** PLANET est doté d'un chargeur CA-CC et injecte le courant CC DC dans la fiche de la paire de câble torsafée en conformité avec la norme IEEE, reprise dans le tableau ci-après:

Modèle	Chargeur CA-CC spec. requis.	Correspondance pour fiche PoE
POE-151	Entrée: 100~240V CA	4/5(+), 7/8(-)
POE-152	Sortie: 48V CC	1/2(+), 3/6(-)
POE-161	Entrée: 100~240C CA Sortie: 56V CC	4/5(+), 7/8(-)

Un câble de catégorie 5/5e/6 UTP/STP à 8 fiches est requis pour l'installation. Le câble UTP à 4 fiches (fiche 1/2, 3/6) ne fonctionne pas avec POE-151/161 et ne fonctionne qu'avec POE-152 sur une connexion réseau Ethernet 10/100Base-TX.



Remarque

Le **Fendeur PoE** PLANET et l' **injecteur PoE** PLANET (ex. POE-151, POE-152 et POE-161) peuvent être installés par paires. L'utilisation d'un tiers est autorisée si le système est conforme aux normes IEEE 802.3af ou IEEE 802.3af.

5.2 Installation de l'Injecteur PoE

1. Connectez un câble réseau standard depuis l'interrupteur/le port **Ethernet** de la station de travail de l'Injecteur PoE.
2. Connectez le câble long qui sera utilisé pour connecter le système à distance au port "**Ethernet+CC**".
3. Connectez le chargeur CA à la prise "**48V CC**" du POE-151/POE-152. Le voyant DEL reste allumé.
Connectez le chargeur CA à la prise "**56V CC**" du POE-161. Le voyant DEL reste allumé.

4. Connectez les systèmes IEEE 802.3af selon la norme IEEE 802.3af. Le POE-151/POE-152 peut se connecter directement à un système IEEE 802.3af comme par exemple un point d'accès sans fil, un téléphone VoIP ou un appareil photo IP qui supporte l'interface IEEE 802.3af via Ethernet.



Remarque

Lorsque POE-161 conforme à la norme IEEE 802.3at, le POE-161 peut se connecter directement aux nœuds d'extrémité de tout IEEE 802.3at tels que les caméras PTZ (Panoramique, Inclinaison et Zoom) IP, Speed Dome, le point d'accès WLAN de haute consommation d'énergie soutenant l'alimentation de IEEE 802.3at via le port Ethernet.



Schéma 3: Connexion à un système IEEE 802.3af

5. Une fois que POE-151/POE-152 détecte l'existence d'un système IEEE 802.3af, le voyant DEL reste allumé afin de signaler qu'il alimente l'unité. Le même POE-161 qui détecte l'existence d'un système IEEE 802.3at / af.

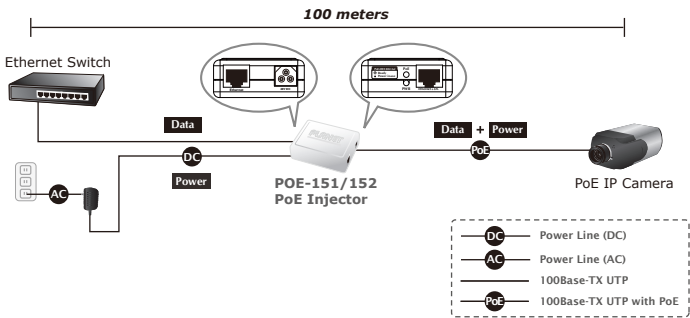

Remarque

Si le système connecté n'est pas totalement conforme avec la norme IEEE 802.3af, le voyant DEL du POE-151/POE-152 ne restera pas allumé.



Remarque

1. Puisque le port POE-161 PoE supporte les sorties électriques 56V CC PoE, vérifiez que le système électrique est adapté à une tension électrique entre 52 et 56V CC. Autrement, le système électrique risquerait d'être endommagé.
2. Si le système connecté n'est pas entièrement conforme avec la norme IEEE 802.3at / af, le voyant DEL du POE-161 ne restera pas allumé.

5.3 Installation de l'Injecteur PoE et Fendeur PoE

Pour les systèmes à distance ou le matériel Ethernet, le **Injecteur PoE et Fendeur PoE** peuvent fonctionner en paires afin d'alimenter ces systèmes en courant CC. Le tableau ci-dessous montre les modèles de **Fendeurs PoE PLANET**:

Modèle	Norme PoE	Sortie électrique CC	Vitesse de transfert
POE-151S	IEEE 802.3af	5V / 12V CC	10/100Mbps
POE-152S	IEEE 802.3af	5V / 12V CC	10/100/1000Mbps
POE-162S	IEEE 802.3at	12V / 24V CC	10/100/1000Mbps

1. Suivez les étapes 1, 2 et 3 de la Rubrique 5.2 pour la connexion.
2. Connectez le câble UTP depuis le port **"Ethernet"** du **Fendeur PoE** au port RJ-45 du système à distance.
3. Connectez la prise CC de la **"SORTIE CC"** du Fendeur PoE au système à distance.



Schéma 4: Architecture de connexion via l'injecteur PoE et le Fendeur PoE



Remarque

Veillez vous assurer que la tension de sortie du Fendeur PoE est correcte avant d'alimenter le système à distance. Cela pourra endommager le système à distance.

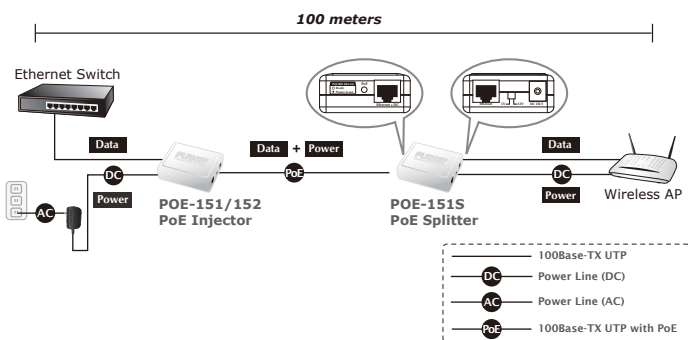
6. Caractéristiques du produit

Produit		POE-151	POE-152	POE-161
Caractéristiques du matériel				
Interface	Port d'entrée des données	1 x RJ-45 STP		
	"PoE (Données + Power)" Port de sortie	1 x RJ-45 STP		
	Prise électrique d'entrée CC	1 x 48V DC		1 x 56V DC
LED Indicator		Système: Power x 1 (Jaune) Port PoE: PoE en cours d'utilisation x 1 (Vert)		Système: Power x 1 (Vert) Port PoE: PoE en utilisation x 1 (Vert)
Câble Réseau	Cat. UTP 5/5e/6, jusqu'à 100m (328pieds)			
Taux de données	10/100Mbps	10/100/1000Mbps	10/100/1000Mbps	
Dimension (P x D x H)	73 x 55 x 24 mm	73 x 55 x 24 mm	95 x 70 x 25 mm	
Poids	50g	50g	83g	
Tension d'entrée	48V CC, 0,4A	48V CC, 0,4A	56V CC, 0,53A	
Caractéristiques d'alimentation	100-240V AC, 50/60Hz			
Consommation électrique	15,4 Watts max.	15,4 Watts max.	30 Watts max.	
Alimentation via Ethernet				
Norme PoE	IEEE 802.3af Alimentation via Ethernet / PSE			IEEE 802.3at / af Alimentation via Ethernet / PSE
Sortie d'alimentation PoE	48V CC / 15,4 Watts			56V CC / 30 Watts
Type d'alimentation électrique PoE	Mi-portée	Portée de fin	Mi-portée	
Correspondance par fiche	4/5(+), 7/8(-)	1/2(+), 3/6(-)	4/5(+), 7/8(-)	
Conformité aux normes				
IEEE 802.3 10Base-T Ethernet	■	■	■	
IEEE 802.3u 100Base-TX Ethernet Rapide	■	■	■	
IEEE 802.3ab 1000Base-T Gigabit Ethernet	-	■	■	
IEEE 802.3af Alimentation via Ethernet	■	■	■	
IEEE 802.3at Alimentation via Ethernet	-	-	■	
Conformité avec les réglementations	FCC catégorie B, Repère CE	FCC Catégorie A, Repère CE	FCC Catégorie A, Repère CE	
Environnement				
Température de fonctionnement	0 ~ 50 Degrés C			
Température de stockage	-10 ~ 70 Degrés C			
Humidité	5 ~ 95% (Non-condensation)			

1. Überblick

Danke, dass Sie die PLANET **IEEE 802.3at / af Power over Ethernet (Strom über Ethernet) Injektoren** gekauft haben. Diese PoE Injektoren funktionieren mit allen Stromgerät (PD) die auch die IEEE 802.3af / at Standards unterstützen. Die Modelle unten beinhalten:

Modell	PoE Standard	Max. PoE Output	Strom Input	Durchreiche Geschwindigkeit
POE-151	IEEE 802.3af	15.4 Watts	48V DC	10/100Mbps
POE-152	IEEE 802.3af	15.4 Watts	48V DC	10/100/1000Mbps
POE-161	IEEE 802.3at / af	30 Watts	56V DC	10/100/1000Mbps

Mit Ausnahme der speziellen Bedingungen des **"PoE Injektor"** sind in den folgenden Abschnitten die oben aufgelisteten Modelle gemeint.

2. Packungsinhalt

Öffnen Sie die Box des PoE Injektors oben und packen Sie vorsichtig den Inhalt aus. Die Box soll die folgenden Artikel enthalten:

POE-151 / POE-152	POE-161
<ul style="list-style-type: none"> ● 802.3af PoE Strom über Ethernet Injektor x 1 ● Benutzerhandbuch x 1 ● DC 48V Stromadapter x 1 	<ul style="list-style-type: none"> ● IEEE 802.3at Hochleistung über Ethernet Injektor x 1 ● Benutzerhandbuch x 1 ● DC 56V Stromadapter x 1 ● Stromkabel x 1



Hinweis

Sollte irgendein Artikel fehlen, oder beschädigt sein, kontaktieren Sie bitte sofort Ihren Händler. Wenn möglich retournieren Sie bitte die Box mit dem originalen Verpackungsmaterial und verwenden Sie dies für die Wiedereinpackung, falls Sie das Gerät für den Austausch oder Reparatur zurückschicken.

3. Produkt Ansicht

POE-151 / POE-152

Es gibt zwei RJ-45 verbogene Jack Paare, eine DC 48V Steckdose und zwei LED Anzeigen.



Bild 1: POE-151 / POE-152

POE-161

Es gibt zwei RJ-45 verbogene Jack Paare, eine DC 56V Steckdose und zwei LED Anzeigen.

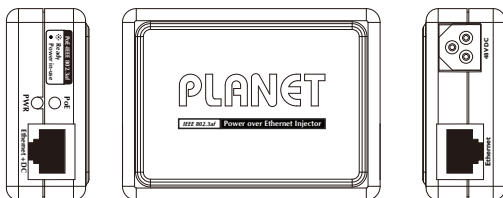

Bild 2: POE-161 Überblick

4. LED Anzeige

LED	Beschreibung
Strom	Lichter die zeigen, dass der PoE Injektor Strom vom AC-DC Adapter hat.
PoE verwendet	Lichter die zeigen, dass der PoE Injektor DC in-line Strom liefert.

5. Hardware Installation

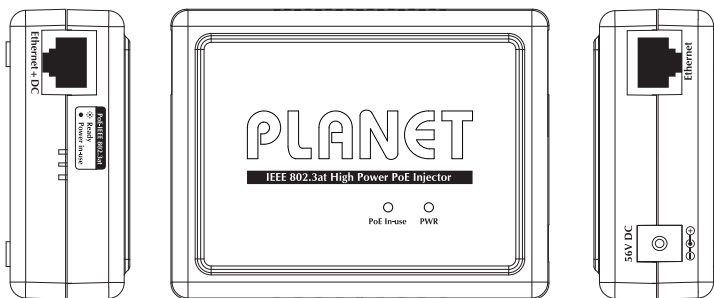
Dieser Abschnitt beschreibt die Hardware Funktionen des **PoE Injektor**. Bevor Sie irgendein Netzwerk Gerät mit dem **PoE Injektor** verbinden, lesen Sie bitte sorgfältig diesen Abschnitt.

5.1 Vor der Installation

Vor der Installation wird vorgeschlagen Ihre Netzwerkkumgebung zu überprüfen. Der PLANET **PoE Injektor** ist mit einem AC-DC Adapter versehen und injiziert den DC Strom in den Pin des verbogenen Doppelkabels dem IEEE Standard entsprechend, die Strom und Pin Steuerungsverbindungen werden in der Tabelle unten gezeigt:

Modell	Spez. des benötigten AC-DC Adapters	PoE Pin Steuerung
POE-151	Input: 100~240V AC	4/5(+), 7/8(-)
POE-152		1/2(+), 3/6(-)
POE-161	Entrée: 100~240C CA, Sortie: 56V CC	4/5(+), 7/8(-)

5/5e/6 UTP/STP Kategorie Kabel mit 8-Adern werden für die Installation benötigt. UTP Kabel mit 4-Adern (Pin 1/2, 3/6) funktionieren nicht mit POE-151/161 und können nur mit POE-152 in 10/100Base-TX Ethernet funktionieren.



Hinweis

Der PLANET **PoE Splitter** und der PLANET **PoE Injektor** (ausgenommen der POE-151, POE-152 und POE-161) können in Paar installiert werden. Die Verwendung vom Gerät vom Dritten ist erlaubt, falls das Gerät an den IEEE 802.3at oder IEEE 802.3af Standard angepasst ist.

5.2 PoE Injektor Installation

1. Verbinden Sie ein Standard Netzwerk Kabel vom Schalter/Arbeitsstation mit dem **"Ethernet"** Port des **PoE Injektors**.
2. Schließen Sie das lange Kabel an, welches für die Verbindung des Remote Gerätes zum Port **"Ethernet+DC"** verwendet wird.
3. Verbinden Sie den AC Adapter mit dem **"DC 48V"** des POE-151/ POE-152. Die Strom LED wird anleuchten.

Verbinden Sie den AC Adapter mit dem **"DC 56V"** des POE-161. Die Strom LED wird anleuchten.

4. Schließen Sie die IEEE 802.3af Geräte an. Basiert auf dem IEEE 802.3af Standard, kann das POE-151/POE-152 direkt mit irgendwelchen IEEE 802.3af Ende-Knoten als kabelloser Zugangspunkt verbunden werden. VoIP Telefone und IP Kameras, die die IEEE 802.3af Strom über Ethernet Interface unterstützen.



Hinweis

Bei der POE-161, Basis gemäß IEEE 802.3at Standard, kann das POE-161 direkt mit irgendwelchen IEEE 802.3at Endknoten, solche wie PTZ (Schwenk-, Neigungs- & Zoom-) IP Kamera, Geschwindigkeits-Haube, LAN Zugangsknoten mit Hochleistungsverbrauch, die den IEEE 802.3at Power over Ethernet (Strom über Ethernet) Port unterstützen, verbunden werden.



Bild 3: Verbindung zum IEEE 802.3af Gerät

5. Nachdem das POE-151/POE-152 das Vorhandensein eines IEEE 802.3af Gerätes entdeckt, leuchtet die LED Anzeige an, ist auf "ON" und zeigt dass, das Gerät unter Strom ist. Das gleiche passiert beim POE-161 wenn es das Vorhandensein eines IEEE 802.3at / af Gerätes entdeckt.

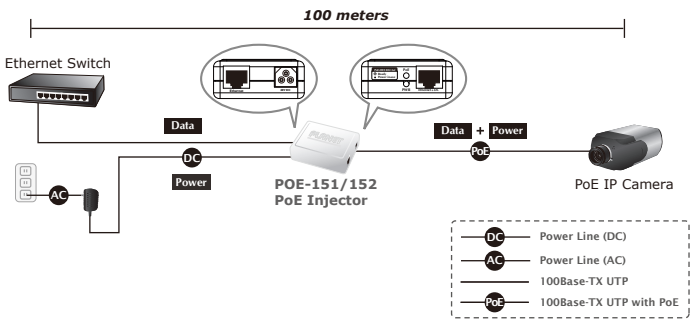

Hinweis

Falls das verbundene Gerät nicht vollständig dem IEEE 802.3af Standard entspricht, wird die LED Anzeige des POE-151/POE-152 nicht anleuchten.



Hinweis

1. Da der POE-161 PoE Port den 56V DC PoE Stromoutput unterstützt, überprüfen Sie ihn bitte und stellen Sie sicher, dass das Gerät unter Strom (PD) im zulässigen DC Strombereich von 52 bis 56V DC ist. Sonst wird Ihr Gerät unter Strom(PD) beschädigt.
2. Falls das verbundene Gerät dem IEEE 802.3at / af Strom über Ethernet nicht vollständig entspricht, wird die LED Anzeige des POE-161 nicht anleuchten.

5.3 PoE Injektor und PoE Splitter Installation

Bei einem nicht PoE Remote Gerät oder Ethernet Vorrichtung, können der **PoE Injektor** und der **PoE Splitter** paarweise funktionieren um DC Strom für diese Geräte zu bieten, die Tabelle unten zeigt das Modell PLANET **PoE Splitter**:

Modell	PoE Standard	DC Strom Output	Durchreiche Geschwindigkeit
POE-151S	IEEE 802.3af	5V / 12V DC	10/100Mbps
POE-152S	IEEE 802.3af	5V / 12V DC	10/100/1000Mbps
POE-162S	IEEE 802.3at	12V / 24V DC	10/100/1000Mbps

1. Folgen Sie den Schritten 1, 2 und 3 vom Abschnitt 5.2 für die Verbindung.
2. Verbinden Sie das UTP Kabel in der Verpackung vom **"Ethernet"** des **PoE Splitters** mit dem RJ-45 Port des Remote Gerätes.
3. Verbinden Sie den richtigen DC Stecker vom **"DC OUT"** des PoE Splitters mit dem Remote Gerät.



Bild 4: Verbindungsstruktur über den PoE Injektor und den PoE Splitter



Hinweis

Bitte stellen Sie sicher, dass die PoE Splitter Output Spannung richtig ist, bevor Sie zum Remote Gerät Strom anders zuführen, da sonst das Remote Gerät beschädigt werden kann.

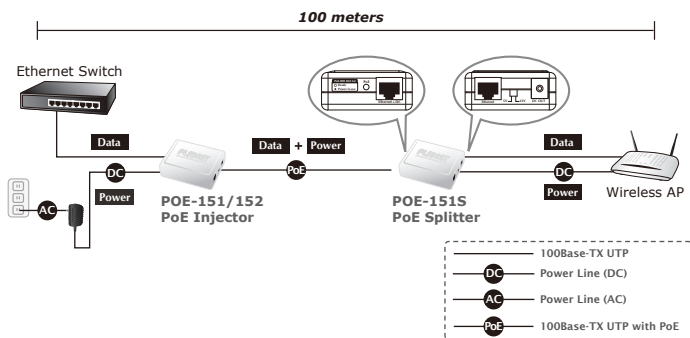
6. Produkt Spezifikation

Produkt		POE-151	POE-152	POE-161
Hardware Spezifikation				
Interface	"Daten" Input Port	1 x RJ-45 STP		
	"PoE (Daten + Strom)" Output Port	1 x RJ-45 STP		
	DC Input Steckdose	1 x 48V DC		1 x 56V DC
LED Anzeiger		System: Strom x 1 (Gelb) PoE Port: PoE in Verwendung x 1 (Grün)		System: Strom x 1 (Grün) PoE Port: PoE in Verwendung x 1 (Grün)
Netzwerk Kabel		UTP Kat. 5/5e/6, bis zu 100m (328ft)		
Datenrate		10/100Mbps	10/100/1000Mbps	10/100/1000Mbps
Abmessungen (W x T x H)		73 x 55 x 24 mm	73 x 55 x 24 mm	95 x 70 x 25 mm
Gewicht		50g	50g	83g
Einheit Input Spannung		DC 48V, 0.4A	DC 48V, 0.4A	DC 56V, 0.53A
Stromanforderung		100-240V AC, 50/60Hz		
Stromverbrauch		15.4 Watt max.	15.4 Watt max.	30 Watt max.
Power over Ethernet (Strom über Ethernet)				
PoE Standard		IEEE 802.3af Power over Ethernet / PSE		IEEE 802.3at / af Power over Ethernet / PSE
PoE Strom Output		DC 48V / 15.4 Watt		DC 56V / 30 Watt
PoE Stromversorgungstyp		Mittler-Span	End-Span	Mittler-Span
Strom Pin Steuerung		4/5(+), 7/8(-)	1/2(+), 3/6(-)	4/5(+), 7/8(-)
Übereinstimmung der Standards				
IEEE 802.3 10Base-T Ethernet		■	■	■
IEEE 802.3u 100Base-TX Schnelles Ethernet		■	■	■
IEEE 802.3ab 1000Base-T Gigabit Ethernet		-	■	■
IEEE 802.3af Power over Ethernet		■	■	■
IEEE 802.3at Power over Ethernet		-	-	■
Übereinstimmung der Einstellungen		FCC Klasse B, CE Marke	FCC Klasse A, CE Marke	FCC Klasse A, CE Marke
Umgebung				
Betriebstemperatur		0 ~ 50 Grad C		
Lagerungstemperatur		-10 ~ 70 Grad C		
Feuchtigkeit		5 ~ 95% (ohne Betauung)		

1. Informazioni generali

Grazie per aver acquistato il **Power over Ethernet Injectors** della PLANET **compatibile con lo standard IEEE 802.3at / af**. Questo PoE injectors interagisce con tutti I Power Device (PD) che sono compatibili con lo standard IEEE 802.3af / at. la tabella seguente illustra i modelli disponibili:

Modello	PoE Standard	Max. PoE Out	Power In	Velocità trasf. dati
POE-151	IEEE 802.3af	15.4 Watts	48V DC	10/100Mbps
POE-152	IEEE 802.3af	15.4 Watts	48V DC	10/100/1000Mbps
POE-161	IEEE 802.3at / af	30 Watts	56V DC	10/100/1000Mbps

Nelle sezioni che seguono per la dicitura "**PoE Injector**", si intendono i modelli indicati nella lista.

2. Contenuto della confezione

Aprire la confezione del PoE Injector con attenzione. Il contenuto dovrebbe essere il seguente:

POE-151 / POE-152	POE-161
<ul style="list-style-type: none"> ● L' Injector 802.3af PoE x 1 ● Manuale Utente x 1 ● Alimentatore DC 48V x 1 	<ul style="list-style-type: none"> ● L' Injector 802.3at High PoE x 1 ● Manuale Utente x 1 ● Alimentatore DC 56V x 1 ● Cavo alimentazione x 1



Nota

Se uno dei component elencati manca oppure è danneggiato, si prega di contattare il rivenditore. Possibilmente, conservare la confezione originale, ed usarla per imballare il prodotto nel caso in cui ci sia la necessità di inviare il prodotto in riparazione.

3. Vista del Prodotto

POE-151 / POE-152

Sono presenti due porte RJ-45, una presa di alimentazione DC 48V e due LED che indicano lo stato di funzionamento.



Figura 1: POE-151 / POE-152

POE-161

Sono presenti due porte RJ-45, una presa di alimentazione DC 56V e due LED che indicano lo stato di funzionamento.

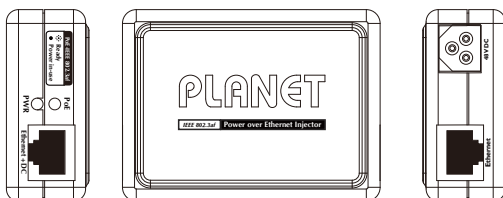

Figura 2: POE-161 Informazioni generali

4. LED di stato

LED	Description
Power	Quando è acceso il PoE Injector è alimentato.
PoE In-use	Quando è acceso il PoE Injector sta fornendo alimentazione PoE.

5. Installazione

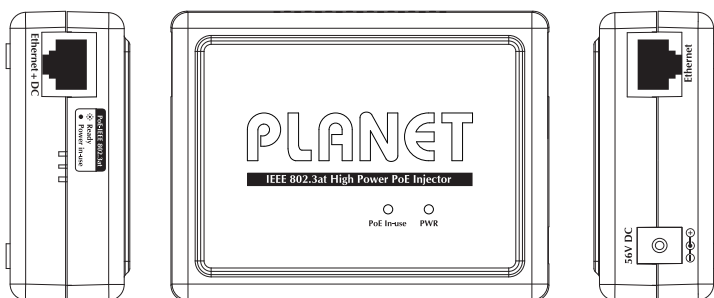
In questa sezione sono descritte le funzionalità del **PoE Injector**. Prima di connettere un dispositivo al **PoE Injector**, leggere attentamente questo capitolo.

5.1 Prima dell'installazione

Prima dell'installazione si raccomanda di controllare le specifiche della Rete LAN. Il **PoE Injector** della PLANET fornisce l'alimentazione utilizzando alcune coppie del cavo di rete secondo gli standard IEEE, nello specifico la tavola che segue illustra lo schema delle connessioni:

Modello	Specifiche Alimentazione	Specifiche PoE
POE-151	Input: 100~240V AC	4/5(+), 7/8(-)
POE-152	Output: 48V DC	1/2(+), 3/6(-)
POE-161	Input: 100~240C AC Output: 56V DC	4/5(+), 7/8(-)

Per l'installazione sono richiesti i cavi di categoria 5/5e/6 UTP/STP a 8 fili. I cavi UTP con 4 fili (solo con le coppie 1/2, 3/6 cablate) non funzionano con il POE-151/161, ma funzionano solo con il POE-152 a 10/100 Base-TX Ethernet.



Nota

I **PoE Injector** e **PoE Splitter** PLANET (es. POE-151S, POE-152S e POE-162S) possono essere utilizzati in coppia. Per poter utilizzare dispositivi di terze parti, devono rispettare gli standard IEEE 802.3at o IEEE 802.3af.

5.2 Installazione del PoE Injector

1. Connettere un cavo di rete standard dallo Switch/workstation alla porta **"Ethernet"** del **PoE Injector**.
2. Connettere il cavo di rete che sarà usato per collegare il dispositivo remoto da alimentare alla porta **"Ethernet+DC"**.
3. Collegare l'alimentatore alla porta **"DC 48V"** del POE-151/POE-152. Il LED di alimentazione si accenderà.
Collegare l'alimentatore alla porta **"DC 56V"** del POE-161. Il LED di alimentazione si accenderà.

4. Collegare il dispositivo compatibile IEEE 802.3af. Il POE-151/POE-152 utilizzando lo standard IEEE 802.3af, può essere connesso direttamente con dispositivo IEEE 802.3af end-nodes come access point wireless, telefoni VoIP e IP camera con interfaccia PoE compatibile allo standard IEEE 802.3af.



Nota

Il POE-161 è basato sullo standard IEEE 802.3at, e può essere collegato direttamente con qualsiasi dispositivo compatibile IEEE 802.3at end-nodes, come PTZ (Pan, Tilt & Zoom) IP camera, Speed Dome, access point wireless che supportano lo standard IEEE 802.3at Power over Ethernet e richiedono un'alimentazione con maggiore potenza.



Figura 3: esempio di connessione dispositivi IEEE 802.3af

5. Il POE-151/POE-152 una volta individuato un dispositivo compatibile IEEE 802.3af, accenderà il LED di stato. Il POE-161 utilizza lo stesso procedimento.

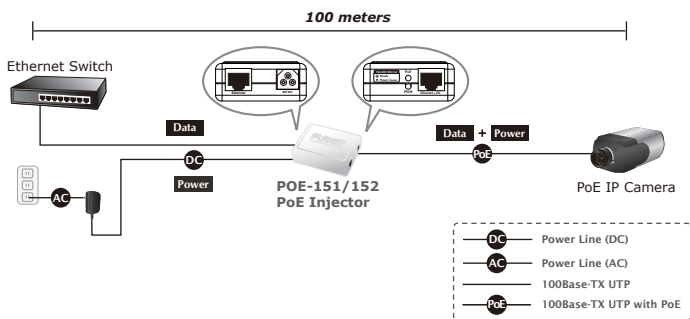

Nota

Se il dispositivo collegato non è completamente compatibile con lo standard IEEE 802.3af, il LED del POE-151/POE-152 non si accenderà.



Nota

1. Siccome la porta PoE del POE-161 fornisce 56V DC PoE, controllare che il Powered Device (PD) possa funzionare con alimentazione compresa tra 52 e 56V DC. Altrimenti il Powered Device (PD) si potrebbe danneggiare.
2. Se il dispositivo connesso non è completamente compatibile con lo standard IEEE 802.3at / af Power over Ethernet, il LED del POE-161 non si accenderà.

5.3 Installazione PoE Injector e PoE Splitter

Se il dispositivo remoto non è compatibile PoE oppure non è installato in una rete LAN, il **PoE Injector** ed il **PoE Splitter** possono lavorare in coppia per fornire l'alimentazione necessaria, nella tabella che segue vengono illustrati i modelli di **PoE Splitters** disponibili della PLANET:

Modello	Standard PoE	Alimentazione di uscita	Velocità di trasferimento dati
POE-151S	IEEE 802.3af	5V / 12V DC	10/100Mbps
POE-152S	IEEE 802.3af	5V / 12V DC	10/100/1000Mbps
POE-162S	IEEE 802.3at	12V / 24V DC	10/100/1000Mbps

1. Seguire i passi 1, 2 e 3 della sezione 5.2 per la connessione.
2. Collegare il cavo UTP fornito nella confezione dalla porta **"Ethernet"** del **PoE splitter** alla porta RJ-45 del dispositivo remoto.
3. Collegare l'apposito alimentatore al **"DC OUT"** dello Splitter PoE al dispositivo remoto.



Figura 4: esempio di Connessione utilizzando PoE Injector e PoE Splitter



Nota

Assicurarsi che il voltaggio di uscita dello Splitter PoE sia corretto prima di collegare il dispositivo remoto, altrimenti potrebbe danneggiarsi.

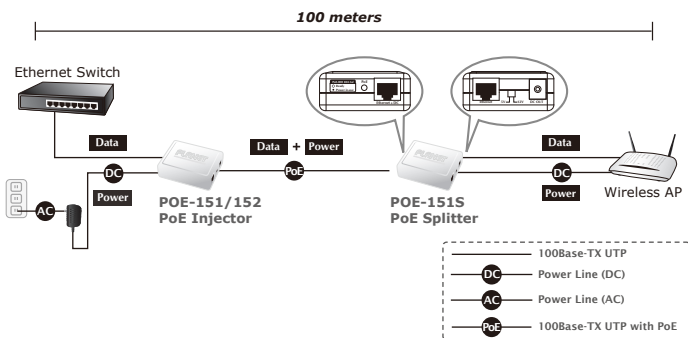
6. Specifiche del Prodotto

Prodotto		POE-151	POE-152	POE-161
Specifiche tecniche				
Interfaccia	"Data" Porta di ingresso	1 x RJ-45 STP		
	"PoE (Dati + alimentazione)" Porta di uscita	1 x RJ-45 STP		
	DC Input power socket	1 x 48V DC	1 x 56V DC	
LED	Sistema: alimentazione x 1 (Giallo) PoE Port: PoE in Uso x 1 (Verde)		Sistema: alimentazione x 1 (Verde) Porta PoE: PoE in Uso x 1 (Verde)	
Cavo di rete	UTP Cat. 5/5e/6, fino a 100m			
Trasferimento dati	10/100Mbps	10/100/1000Mbps	10/100/1000Mbps	
Dimensioni (L x P x A)	73 x 55 x 24 mm	73 x 55 x 24 mm	95 x 70 x 25 mm	
Peso	50g	50g	83g	
Alimentazione in ingresso	DC 48V, 0.4A	DC 48V, 0.4A	DC 56V, 0.53A	
Requisiti alimentazione	100-240V AC, 50/60Hz			
Consumo	15.4 Watts max.	15.4 Watts max.	30 Watts max.	
Power over Ethernet				
Standard PoE	IEEE 802.3af Power over Ethernet / PSE		IEEE 802.3at / af Power over Ethernet / PSE	
Potenza PoE erogata	DC 48V / 15.4 Watts		DC 56V / 30 Watts	
Tipologia alimentazione PoE	Mid-Span	End-Span	Mid-Span	
Pin cavo rete utilizzati per PoE	4/5(+), 7/8(-)	1/2(+), 3/6(-)	4/5(+), 7/8(-)	
Conformità agli standards				
IEEE 802.3 10Base-T Ethernet	■	■	■	
IEEE 802.3u 100Base-TX Fast Ethernet	■	■	■	
IEEE 802.3ab 1000Base-T Gigabit Ethernet	-	■	■	
IEEE 802.3af Power over Ethernet	■	■	■	
IEEE 802.3at Power over Ethernet	-	-	■	
Conforme alla normative	FCC Class B, CE mark	FCC Class B, CE mark	FCC Class A, CE mark	
Specifiche ambientali				
Temperature di funzionamento	0 ~ 50 Degrés C			
Limite Temperatura	-10 ~ 70 Degrés C			
Umidità	5 ~ 95% (Non-condensation)			

1. Apresentação

Obrigado por adquirir PLANET **IEEE 802.3at / af Energia para Injectores Ethernet**. Estes injectores PoE funcionam com qualquer Equipamento Fonte de Energia (PD) que também respeita os padrões IEEE 802.3af / at. Os modelos abaixo indicados estão incluídos:

Modelo	PadrãoPoE	Máximo PoE de Saída	Energia de entrada	Velocidade de Transmissão
POE-151	IEEE 802.3af	15.4 Watts	48V DC	10/100Mbps
POE-152	IEEE 802.3af	15.4 Watts	48V DC	10/100/1000Mbps
POE-161	IEEE 802.3at / af	30 Watts	56V DC	10/100/1000Mbps

A não ser que seja especificado, os termos **“Injector PoE”** na seguinte secção referem-se aos modelos listados acima.

2. Conteúdos da Embalagem

Abra cuidadosamente a caixa do Injector PoE e desembalhe cuidadosamente. A caixa deve conter os seguintes objectos:

POE-151 / POE-152	POE-161
<ul style="list-style-type: none">● O Injector PoE 802.3af x 1● Manual de utilização x 1● Adaptador de energia DC 48V x 1	<ul style="list-style-type: none">● O IEEE 802.3at Alto Sinal para Injector Ethernet x 1● Manual de Utilização● Adaptador de energia DC 56V x 1● Dispositivo de Energia x 1



Nota

Se alguma destas peças está em falta ou estiver estragada, por favor contacte o seu fornecedor imediatamente. Se possível, mantenha a embalagem e o material original, e volte a utilizá-los para voltar a embalar o produto caso seja necessário devolver para reparação.

3. Apresentação do Produto

POE-151 / POE-152

Existem dois dispositivos RJ-45 Twisted-Pair, uma ligação DC de 48V e dois indicadores LED.



Figura 1: POE-151 / POE-152

POE-161

Existem dois dispositivos RJ-45 Twisted-Pair, uma ligação DC de 56V e dois indicadores LED.

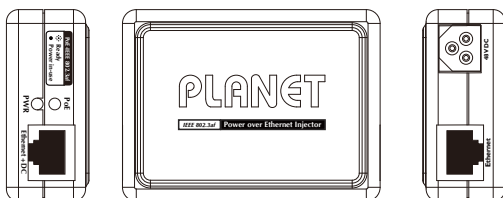

Figura 2: Apresentação POE-161

4. Indicação LED

LED	Descrição
Energia	As luzes indicam se o Injector PoE tem energia do adaptador AC-DC.
PoE em Utilização	As luzes indicam se o Injector PoE fornece energia à linha DC.

5. Instalação do equipamento

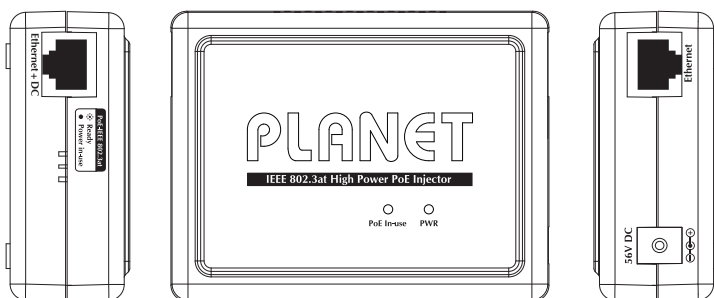
Esta secção descreve as características do equipamento para Injectores PoE. Antes de ligar o Injector PoE a qualquer dispositivo de rede, leia cuidadosamente este capítulo.

5.1 Antes de Instalar

Antes de instalar, recomendamos que verifique o ambiente da sua rede. O Injector PoE PLANET é um adaptador AC-DC que fornece energia DC no cabo seguindo as recomendações IEEE, a energia e os cabos permitidos para estas tarefas encontram-se apresentados em baixo:

Modelo	Especificações do adaptador AC-DC	FunçãoPoE Pin
POE-151	Entrada: 100~240V AC	4/5(+), 7/8(-)
POE-152	Saída: 48V DC	1/2(+), 3/6(-)
POE-161	Entrada: 100~240C AC Saída: 56V DC	4/5(+), 7/8(-)

Categoria 5/5e/6 e cabo UTP/STP com 8 fios necessários para a instalação. O cabo UTP com 4 fios (pin 1/2, 3/6) não trabalha com o POE-151/161 e pode apenas trabalhar com POE-152 numa Ethernet 10/100Base-T.



Nota

O **Injector PoE** PLANET e o **Divisor PoE** PLANET (ex. POE-151S, POE-152S e o POE-161S) podem ser instalados aos pares. Utilize um dispositivo que permite e assegura os padrões IEEE 802.3at ou IEEE 802.3af.

5.2 Instalação do Injector PoE

1. Ligue o cabo de rede padrão ao Computador/estação de trabalho à Ligação "**Ethernet**" e ao **Injector PoE**.
2. Ligue o cabo longo que será utilizado para ligar ao dispositivo remoto e à ligação "**Ethernet+DC**".
3. Ligue o adaptador AC a "**DC 48V**" do POE-151/POE-152. A luz LED vai ligar-se automaticamente.
Ligue o adaptador AC a "**DC 56V**" do POE-161. A luz LED vai ligar-se automaticamente.

4. Ligue aos dispositivos IEEE 802.3af. De acordo com os padrões IEEE 802.3af, o POE-151/POE-152 pode ligar-se directamente com qualquer ponto de acesso sem fios IEEE 802.3af, telefones VoIP e câmaras IP que suportam ligação de Energia para Ethernet IEEE 802.3af.



Nota

Para POE-161, baseados em padrões IEEE 802.3at, o POE-161 pode ligar-se directamente com qualquer terminal IEEE 802.3at tais como PTZ (PAN, Tilt e Zoom) câmaras IP, Ligações Rápidas, e ligações LAN sem fios de alto consume que suportem ligação IEEE 802.3 para ligações Ethernet.



Figura 3: Ligação do Dispositivo IEEE 802.3af

5. Uma vez que o POE-152/POE-152 detecte a existência de um dispositivo IEEE 802.3af, o indicador LED vai manter-se aceso para demonstrar o fornecimento de energia. O mesmo vai acontecer com o POE-161 que detecta a existência de um dispositivo IEEE 802.3at.

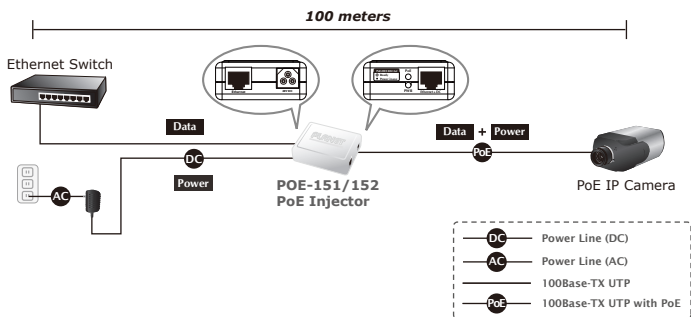

Nota

Se o dispositivo ligado não estiver totalmente de acordo com os padrões IEEE 802.3af, o indicador LED do POE-151/POE-152 não permanece ligado.



Nota

1. Uma vez que o POE-161 e a ligação PoE suporta fornecimento de energia DC 56V e assegura a Ligação do Dispositivo (PD) nos níveis DC aceitáveis entre 52 e 56V DC. Caso contrário, vai danificar a Ligação do Dispositivo (PD).
2. Se o dispositivo ligado não estiver totalmente de acordo com o IEEE 802.3at / af de Energia para Ethernet, o indicador LED do POE-161 não se mantém aceso.

5.3 Instalação do Injector PoE e Divisor PoE

Para dispositivos remotos não PoE ou equipamento Ethernet, o **Injector PoE** e o **Divisor PoE** podem ser ligados aos pares e fornecer energia DC aos dispositivos, a tabela abaixo demonstra o modelo dos **Divisores PoE** PLANET:

Modelo	PadrãoPoE	Ligação de Saída	Velocidade de Transmissão
POE-151S	IEEE 802.3af	5V / 12V DC	10/100Mbps
POE-152S	IEEE 802.3af	5V / 12V DC	10/100/1000Mbps
POE-162S	IEEE 802.3at	12V / 24V DC	10/100/1000Mbps

1. Siga o passo 1, passo 2 e passo 3 da Secção 5.2 para a ligação.
2. Liga o cabo UTP na embalagem à ligação **"Ethernet"** do **divisor PoE** à ligação RJ-45 do dispositivo remoto.
3. Ligue ao DC indicado em **"DC OUT"** do Divisor PoE ao dispositivo remoto.



Figura 4: Esquema de Ligação via PoE Injector e PoE Splitter



Nota

Por favor certifique se o Divisor PoE tem a ligação correcta antes de ligar o dispositivo remoto à rede, caso contrário pode danificar o dispositivo remoto.

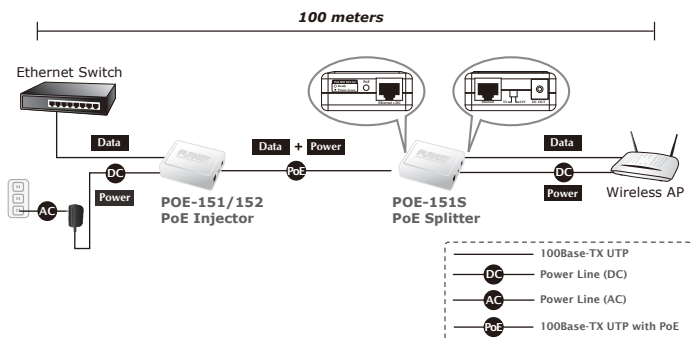
6. Especificação do Produto

Produto		POE-151	POE-152	POE-161
Especificação do Equipamento				
Ligação	Ligação de Entrada de « Dados »	1 x RJ-45 STP		
	Output Port Ligação de saída PoE (Dados + Energia)	1 x RJ-45 STP		
	Ligação à tomada DC	1 x 48V DC	1 x 56V DC	
Indicador LED		Sistema: Energia x 1 (Amarelo) Ligação PoE: PoE em Utilização x 1 (Verde)		Sistema: Energia x 1 (verde) Ligação PoE: PoE em Utilização x 1(Verde)
Cabo de rede		Categoria UTP 5/5e/6, até 100m (328ft)		
Transmissão de dados		10/100Mbps	10/100/1000Mbps	10/100/1000Mbps
Dimensão (C x L x A)		73 x 55 x 24 mm	73 x 55 x 24 mm	95 x 70 x 25 mm
Peso		50g	50g	83g
Unidade de Entrada		DC 48V, 0.4A	DC 48V, 0.4A	DC 56V, 0.53A
Requisitos de Energia		100-240V AC, 50/60Hz		
Consumo de energia		15.4 Watts max.	15.4 Watts max.	30 Watts max.
Ligação para Ethernet				
Padrão PoE		IEEE 802.3at / af Ligação na Ethernet / PSE		IEEE 802.3at / af Ligação na Ethernet / PSE
Sortie d'alimentation PoE		DC 48V / 15.4 Watts		DC 56V / 30 Watts
Type d'alimentation électrique PoE		Mid-Span Médio	End-Span Completo	Mid-Span Médio
Correspondance par fiche		4/5(+), 7/8(-)	1/2(+), 3/6(-)	4/5(+), 7/8(-)
Padrões suportados				
IEEE 802.3 para Ethernet 10Base-T		■	■	■
IEEE 802.3u para Ethernet 100Base-T		■	■	■
IEEE 802.3ab para Ethernet 1000Base-T Gigabit		-	■	■
IEEE 802.3af para Energia de Ethernet		■	■	■
IEEE 802.3at para Energia de Ethernet		-	-	■
Requisitos de Regulação		FCC Classe B, marca CE	FCC Classe B, marca CE	FCC Classe A, marca CE
Ambiente				
Temperatura de Utilização		0 ~ 50 Graus C		
Temperatura de Armazenamento		-10 ~ 70 Graus C		
Humidade		5 ~ 95% (Sem condensação)		

1. Обзор

Благодарим за покупку **сплиттера с питанием через Ethernet (PoE) PLANET IEEE 802.3at / af. Инжекторы**. Этот инжекторы PoE будет работать от любого Устройство питания (PD) , поддерживающего стандарты IEEE 802.3af / at. Поддерживаются модели, указанные ниже:

Модель	Стандарт PoE	Макс. вых. питание через Ethernet	Вход. питание	Пропускная скорость
POE-151	IEEE 802.3af	15.4 Ватт	48В пост. тока	10/100Mbps
POE-152	IEEE 802.3af	15.4 Ватт	48В пост. тока	10/100/1000Mbps
POE-161	IEEE 802.3at / af	30 Ватт	56В пост. тока	10/100/1000Mbps

Если не указано иное, под термином **«Инжектор PoE»** в следующем разделе, подразумеваются модели, указанные выше.

2. В комплект входят

Откройте коробку с инжектором PoE и аккуратно распакуйте его. В коробке должны находиться следующие предметы:

POE-151 / POE-152	POE-161
<ul style="list-style-type: none">● Инжектор 802.3af PoE x 1● Руководство пользователя x 1● Блок питания 48В пост. тока x 1	<ul style="list-style-type: none">● Инжектор с питанием высокой мощности через Ethernet x 1● Руководство пользователя x 1● Блок питания 56В пост.тока x 1● Шнур питания x 1



Примечание

Если какая-либо деталь отсутствует или повреждена, пожалуйста, незамедлительно свяжитесь с вашим дилером. При возможности, сохраните коробку, содержащую оригинальную упаковку, и повторно используйте ее для упаковки продукта, в случае, если его нужно будет вернуть для ремонта.

3. Внешний вид продукта

POE-151 / POE-152

На корпусе расположены два разъема витой пары RJ-45, одно гнездо питания 48В пост.тока и два светодиода индикатора.



Рисунок 1: POE-151 / POE-152

POE-161

На корпусе расположены два разъема витой пары RJ-45, одно гнездо питания 56В пост.тока и два светодиода индикатора.

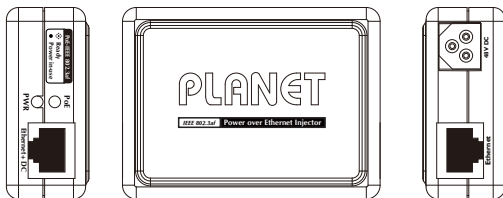

Рисунок 2: Обзор POE-161

4. Светодиодная индикация

Светодиод	Описание
Питание	Горит, когда на Инжектор PoE подается питание от адаптера питания с преобразователем постоянного-переменного тока.
PoE используется	Горит, когда Инжектор PoE подает питание постоянного тока.

5. Установка оборудования

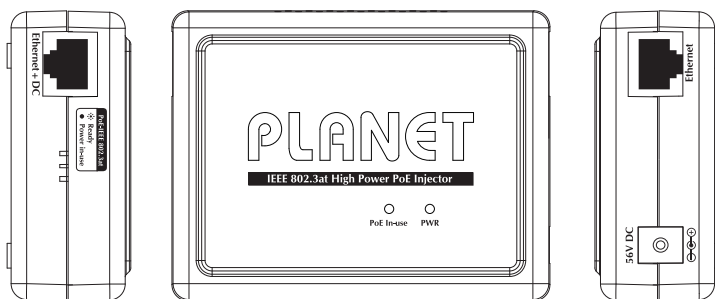
Этот раздел описывает особенности аппаратных средств **Инжектор PoE**. Перед подключением любого сетевого устройства к **Инжектор PoE**, внимательно прочтите этот раздел.

5.1 Перед установкой

Перед установкой рекомендуется проверить ваше сетевое окружение. Инжектор PoE PLANET, оборудованный блоком питания, подает напряжение постоянного тока на контакт витой пары в соответствии со стандартами IEEE, соотношение питания и определение контактов указано в таблице ниже.

Модель	Требуемые характеристики блока питания	Назначение контактов PoE
POE-151	Вход: 100~240В перем.тока	4/5(+), 7/8(-)
POE-152	Выход: 48В пост.тока	1/2(+), 3/6(-)
POE-161	Вход: 100~240В перем.тока Выход: 56В пост.тока	4/5(+), 7/8(-)

Для установки требуются 8-жильные кабели категории 5/5e/6 UTP/STP. Кабель витая пара с 4 жилами (контакты 1/2, 3/6) не могут работать с POE-151/161 и могут работать только с POE-152 в сети Ethernet 10/100Base-TX.



Примечание

Т Сплиттер с питанием от Ethernet PLANET и Инжектор с питанием от Ethernet PLANET (например, POE-151, POE-152 и POE-161) могут устанавливаться в паре. Использование от сторонних производителей допускается, только если эти устройства соответствуют стандартам IEEE 802.3at или IEEE 802.3af.

5.2 Установка Инжектора PoE

1. Подключите стандартный сетевой кабель от коммутатора/рабочей станции к разъему **"Ethernet"** на **Инжекторе PoE**.
2. Подключите длинный кабель, который будет использован для подключения удаленного устройства, к порту **"Ethernet+DC"**.
3. Подключите блок питания к разъему **"DC 48V"** на POE-151/POE-152. Загорится индикатор питания. Подключите блок питания к разъему **"DC 56V"** на POE-161. Загорится индикатор питания.
4. Соедините устройства IEEE 802.3af. Основываясь на стандарте IEEE 802.3af, POE-151/POE-152 может подключаться непосредственно к любым устройствам IEEE 802.3af, таким как беспроводные точки доступа, телефоны VoIP и IP-камеры, которые поддерживают интерфейс IEEE 802.3af с питанием через Ethernet.



Примечание

Так как POE-161 подчиняется стандарту IEEE 802.3at, POE-161 может напрямую соединиться с любым узловым прибором IEEE 802.3at, например, PTZ (Панорамирование, Наклон и Зум) IP-камеры, Speed Dome, точка доступа беспроводной локальной сети с высоким энергопотреблением, поддерживающая питание IEEE 802.3at через Ethernet порт.



Рисунок 3: Подключение устройства IEEE 802.3af

5. Как только PoE-151/PoE-152 обнаружит наличие устройства IEEE 802.3af, светодиодный индикатор загорится, показывая, что он подает питание на устройство. Таким же образом работает PoE-161 при нахождении устройства IEEE 802.3at / af.

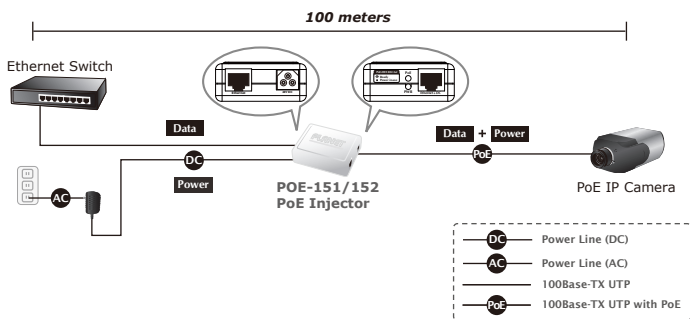

Примечание

Если подключенное устройство не полностью соответствует стандартам IEEE 802.3af, светодиодный индикатор PoE-151/PoE-152 не загорится.



Примечание

1. Поскольку разъем PoE на PoE-161 поддерживает выходное напряжение 56В постоянного тока, пожалуйста, убедитесь, что питаемое устройство поддерживает напряжение от 52 до 56В постоянного тока. В противном случае питаемое устройство может быть повреждено.
2. Если подключенное устройство не полностью соответствует стандартам IEEE 802.3 at / af питание через Ethernet, светодиодный индикатор PoE-161 не загорится.

5.3 IPoE Injector and PoE Splitter Installation

Для удаленных устройств PoE или оборудования Ethernet, Инжектор PoE и Сплиттер PoE могут работать в паре, чтобы обеспечивать питание постоянного тока для тех устройств, которые указаны в списке Сплиттеры PoE ниже:

Модель	Стандарт Питания через Ethernet	Выход напряжения постоянного тока	Пропускная скорость
POE-151S	IEEE 802.3af	5В / 12В пост.тока	10/100Mbps
POE-152S	IEEE 802.3af	5В / 12В пост.тока	10/100/1000Mbps
POE-162S	IEEE 802.3at	12В / 24В пост.тока	10/100/1000Mbps

1. Для подключения следуйте шагам 1, 2 и 3 раздела 5.2.
2. Подключите кабель витая пара идущий от разъема **“Ethernet”** на **Сплиттере PoE** к разъему RJ-45 на удаленном устройстве.

3. Подключите соответствующий разъем "DC OUT" от Сплиттера PoE к удаленному устройству.



Рисунок 4: Подключение через Инжектор PoE и Сплиттер PoE



Примечание

Убедитесь, что выходное питание Сплиттера PoE соответствует необходимому перед тем, как подключать питание на устройство, в противном случае это может повредить удаленное устройство.

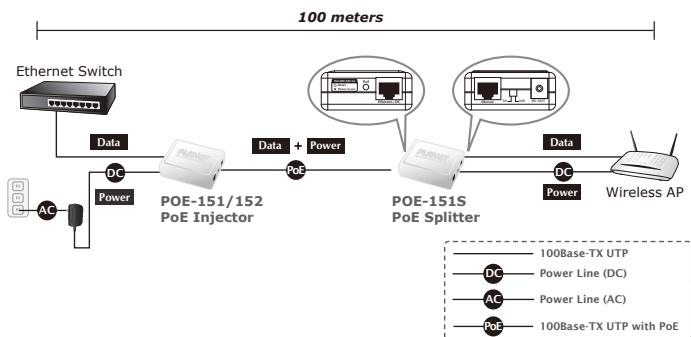
6. Характеристики продукта

Продукт		POE-151	POE-152	POE-161
Аппаратные характеристики				
Интерфейс	Входной разъем "Data" (Данные)	1 x RJ-45 STP		
	Выходной разъем "PoE (Data + Power)" (Питание через Ethernet (Данные + Питание))	1 x RJ-45 STP		
	Входной разъем питания постоянного тока	1 x 48В пост.тока		1 x 56В пост.тока
Светодиодный индикатор		System: Power x 1 (Yellow) PoE Port: PoE in Use x 1 (Green)		System: Power x 1 (Green) PoE Port: PoE in Use x 1 (Green)
Сетевой кабель		Витая пара Кат. 5/5e/6, до 100м (328 футов)		
Скорость передачи данных		10/100Mbps	10/100/1000Mbps	10/100/1000Mbps
Размеры (Ш x Д x В)		73 x 55 x 24 mm	73 x 55 x 24 mm	95 x 70 x 25 mm
Вес		50g	50g	83g
Входное напряжение устройства		48В пост.тока, 0.4А	48В пост.тока, 0.4А	56В пост.тока, 0.53А
Потребление мощности		100-240В перем.тока, 50/60Гц		
Consommation électrique		15.4 Вт макс.	15.4 Вт макс.	30 Вт макс.
Питание через Ethernet				
Стандарт PoE		PoE IEEE 802.3af / ПО		PoE IEEE 802.3at / af / ПО
Выход питание PoE		48В пост.тока / 15.4 Ватт		56В пост.тока / 30 Ватт
Тип питания PoE		Серединное	Конечное	Серединное
Назначение контактов питания		4/5(+), 7/8(-)	1/2(+), 3/6(-)	4/5(+), 7/8(-)
Conformité aux normes				
IEEE 802.3 10Base-T Ethernet		■	■	■
IEEE 802.3u 100Base-TX Fast Ethernet		■	■	■
IEEE 802.3ab 1000Base-T Gigabit Ethernet		-	■	■
IEEE 802.3af Power over Ethernet		■	■	■
IEEE 802.3at Power over Ethernet		-	-	■
Соответствие правилам		FCC Класс B, отметка CE	FCC Класс A, отметка CE	FCC Класс A, отметка CE
Окружающая среда				
Рабочая температура		0 ~ 50 Градусов C		
Температура хранения		-10 ~ 70 Градусов C		
Влажность		5 ~ 95% (без конденсации)		

1. Información general

Gracias por comprar **Inyectores PLANET IEEE 802.3at / af Energía sobre Ethernet**. Estos inyectores PoE funcionan con cualquier Dispositivo de Energía (DE), que también funciona con el IEEE 802.3af / de acuerdo a sus estándares. Se incluyen los modelos a continuación:

Modelo	PoE Standard	Max. PoE Out	Power In	Velocidad de Paso a través
POE-151	IEEE 802.3af	15.4 Vatios	48V DC	10/100Mbps
POE-152	IEEE 802.3af	15.4 Vatios	48V DC	10/100/1000Mbps
POE-161	IEEE 802.3at / af	30 Vatios	56V DC	10/100/1000Mbps

Salvo que se especifique, los términos de **"Inyector PoE"** en las siguientes secciones significan el modelo que aparece más arriba.

2. Contenido del paquete

Al abrir la caja del inyector PoE, desenvolverla cuidadosamente. La caja debe contener los siguientes elementos:

POE-151 / POE-152	POE-161
<ul style="list-style-type: none">● El 802.3af Energía sobre Ethernet Inyector x 1● Manual de Usuario x 1● Adaptador de Energía CC 48V x 1	<ul style="list-style-type: none">● El IEEE 802.3a Alta Energía sobre Ethernet Inyector x 1● Manual de Usuario x 1● Adaptador de Energía CC 56V x 1● Cordón de Energía x 1



Notas

Si alguna de estas piezas falta o están dañadas, póngase en contacto con su distribuidor inmediatamente. Si es posible, guarde la caja incluyendo el material de embalaje original, y utilícelo de nuevo para volver a embalar el producto en caso necesite enviarlo para reparación.

3. Vista general del Producto

POE-151 / POE-152

Hay dos enchufes de Par Trenzado RJ-45, un conector de alimentación CC 48V y dos indicadores LED.



Figura 1: POE-151 / POE-152

POE-161

Hay dos enchufes de Par Trenzado RJ-45, un conector de alimentación CC 56V y dos indicadores LED.

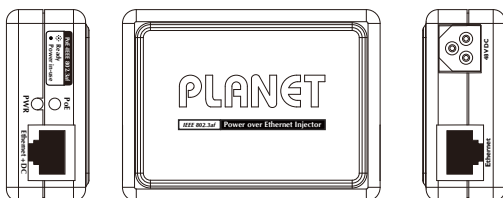

Figura 2: Vista General POE-161

4. Indicación LED

LED	Descripción
Encender	Se enciende para indicar que el inyector PoE tiene el energía del adaptador AC-DC.
PoE En uso	Se enciende para indicar que el inyector PoE está proporcionando energía en línea de alimentación CC.

5. Instalación del hardware

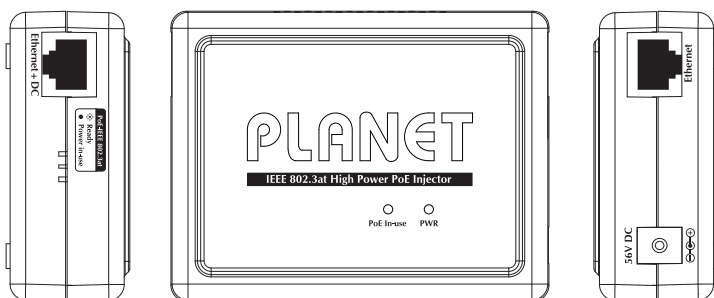
Esta sección describe las características de hardware de **Inyector PoE**. Antes de conectar cualquier dispositivo de red para el **Inyector PoE**, consulte detenidamente este capítulo.

5.1 Antes de la instalación

Antes de su instalación, se recomienda comprobar el entorno de red. El inyector PLANET PoE tiene un adaptador AC-DC e inyecta en la corriente continua en la clavija del cable par trenzado siguiendo el estándar IEEE, la relación de asignación de potencia y el pin está en la tabla de abajo:

Modelo	Especificaciones Requeridas de Adaptador AC-DC	Asignación de PIN PoE
POE-151	Entreda: 100~240V AC	4/5(+), 7/8(-)
POE-152	Salida: 48V CC	1/2(+), 3/6(-)
POE-161	Entrada: 100~240C AC Salida: 56V CC	4/5(+), 7/8(-)

Categoría 5/5e/6 de cable UTP / STP que requiere 8 alambres para la instalación. Cable UTP de 4 alambres (pines 1 / 2, 3 / 6) no puede trabajar con POE-151/161 y sólo puede trabajar con POE-152 en Ethernet 10/100Base-TX.



Notas

El separador PLANET PoE y el inyector PLANET PoE (por ejemplo, POE-151, POE-152 y POE-161) pueden ser instalados en par. El uso de un dispositivo de terceros está permitido si el dispositivo cumple con el estándar IEEE 802.3at o estándar IEEE 802.3af.

5.2 Instalación de Inyector PoE

1. Conecte un cable de red estándar de Interruptor/Estación de trabajo hacia el puerto de inyector PoE **"Ethernet"**.
2. Conecte el cable largo que será utilizado para conectar al dispositivo remoto en el puerto **"Ethernet + DC"**.
3. Conecte el adaptador AC a **"CC 48V"** de POE-151/POE-152. El encendido LED será constante.
Conecte el adaptador AC a **"CC 56V"** de POE-161. El encendido LED será constante.

4. Conecte con los dispositivos IEEE 802.3af. Basándose sobre el estándar IEEE 802.3af, el POE-151/POE-152 puede conectarse directamente con cualquier nodos final IEEE 802.3af como punto de acceso inalámbricos, teléfonos VoIP y cámaras IP que soportan el estándar IEEE 802.3af de alimentación sobre la interfaz Ethernet.



Notas

Para POE-161, basado en el estándar IEEE 802.3at, el POE-161 puede conectarse directamente con cualquier nodo final IEEE 802.3at como de la cámara IP PTZ (Pan, Tilt y Zoom), Domo de Velocidad, punto de acceso inalámbrico LAN de alto consumo de energía que soporte el puerto de Energía sobre Ethernet IEEE 802.3at.



Figura 3: Conexión a dispositivo IEEE 802.3af

5. Una vez que el POE-151/POE-152 detecta la existencia de un dispositivo IEEE 802.3af, el indicador LED estará firmemente encendido mostrando que está proporcionando la energía. El mismo es para el POE-161 que detecta la existencia de un dispositivo IEEE 802.3at / af.

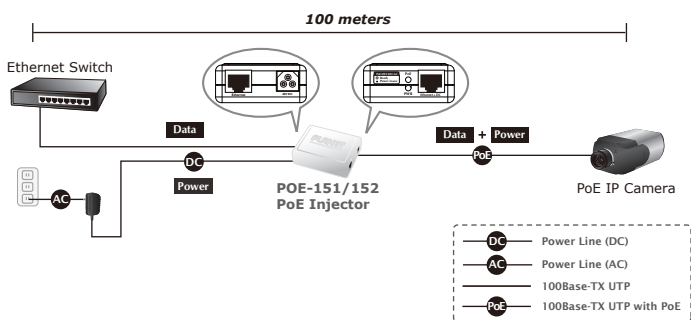

Notas

Si el dispositivo conectado no está cumpliendo plenamente con el estándar IEEE 802.3af, el indicador LED de POE-151/POE-152 no tendrá un encendido constante.



1. Ya que el Puerto PoE POE-161 soporta 56V CC de potencia PoE, por favor compruebe y asegurese de que el rango aceptable de CC del Dispositivo Alimentado (DA) es de 52 a 56V CC. De lo contrario, puede dañar el Dispositivo Alimentado (DA).
2. Si el dispositivo conectado no está cumpliendo plenamente con los estándares IEEE 802.3at / af Energía sobre Ethernet, el indicador LED de POE-161 no tendrá encendido constante.

5.3 PoE Injector and PoE Splitter Installation

Para los dispositivos sin PoE remoto o equipo de Ethernet, el **Inyector PoE e Separador PoE** pueden andar en pares para proveer Energía CC a estos dispositivos, la tabla de abajo muestra el modelo de **Separador PoE PLANET**:

Modelo	Estándar PoE	Energía de Salida DC	Velocidad de Paso a través
POE-151S	IEEE 802.3af	5V / 12V CC	10/100Mbps
POE-152S	IEEE 802.3af	5V / 12V CC	10/100/1000Mbps
POE-162S	IEEE 802.3at	12V / 24V CC	10/100/1000Mbps

1. Siga el paso 1, paso 2 y paso 3 de la sección 5.2 para la conexión.
2. Conecte el cable de UTP en el paquete de **"Ethernet"** del separador PoE al puerto RJ-45 del dispositivo remoto.
3. Conecte el enchufe DC apropiado de **"OUT DC"** del separador PoE en el dispositivo remoto.



Figura 4: Arquitectura de Conexión a través del inyector PoE y Separador PoE



Asegúrese de que el voltaje del Separador PoE es correcto antes de conectar un dispositivo remoto de lo contrario, podría dañar tal dispositivo remoto.

6. Especificación de Producto

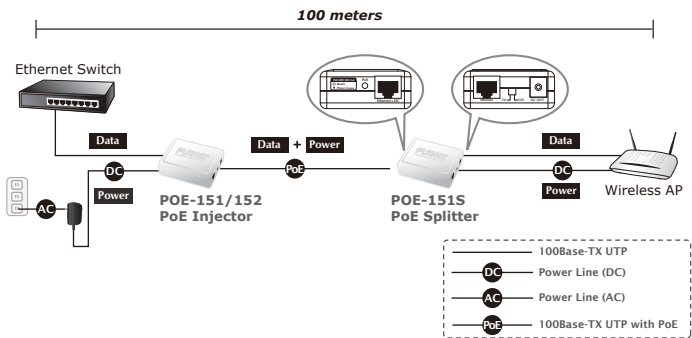
Producto		POE-151	POE-152	POE-161
Especificación de Hardware				
Interface	Puerto de Entrada de "Datos"	1 x RJ-45 STP		
	"PoE (Data + Energía)" Puerto de Salida	1 x RJ-45 STP		
	Enchufe de Entrada de Energía CC	1 x 48V CC		1 x 56V CC
Indicador LED		Sistema: Energía x 1 (Amarillo) Puerto PoE: PoE en Uso x 1 (Verde)		Sistema: Energía x 1 (Verde) Puerto PoE: PoE en Uso x 1 (Verde)
Cable de Red		UTP Cat. 5/5e/6, up to 100m (328ft)		
Ratio de Data		10/100Mbps	10/100/1000Mbps	10/100/1000Mbps
Dimensión (Ancho x Profundidad x Altura)		73 x 55 x 24 mm	73 x 55 x 24 mm	95 x 70 x 25 mm
Peso		50g	50g	83g
Voltage Entrada Unitario		CC 48V, 0.4A	CC 48V, 0.4A	CC 56V, 0.53A
Requerimiento de Energía		100-240V AC, 50/60Hz		
Consumo de Energía		15.4 Vatios max.	15.4 Vatios max.	30 Vatios max.
Energía sobre Ethernet				
Estándar PoE		IEEE 802.3af Energía sobre Ethernet / PSE		IEEE 802.3at / af Energía sobre Ethernet / PSE
Salida de Energía PoE		CC 48V / 15.4 Vatios		CC 56V / 30 Vatios
Tipo de Abastecedor de Energía PoE		Lapso Medio	Lapso Final	Lapso Medio
Asignación de Energía Pin		4/5(+), 7/8(-)	1/2(+), 3/6(-)	4/5(+), 7/8(-)
Estándares de Conformidad				
IEEE 802.3 10 Base-T Ethernet		■	■	■
IEEE 802.3u 100 Base-TX Fast Ethernet		■	■	■
IEEE 802.3ab 1000Base-T Gigabit Ethernet		-	■	■
IEEE 802.3af Energía sobre Ethernet		■	■	■
IEEE 802.3at Energía sobre Ethernet		-	-	■
Cumplimiento de Reglamento		FCC Clase B, marca CE	FCC Clase A, marca CE	FCC Clase A, marca CE
Medio Ambiente				
Temperatura Operativa		0 ~ 50 Grados C		
Temperatura de Almacenamiento		-10 ~ 70 Grados C		
Humedad		5 ~ 95% (Sin condensación)		

EC Declaration of Conformity

For the following equipment:

*Type of Product : IEEE 802.3af Power over Ethernet Injector
*Model Number : POE-151, POE-152

* Produced by:

Manufacturer's Name : **Planet Technology Corp.**
Manufacturer's Address : 10F., No.96, Minquan Rd., Xindian Dist.,
New Taipei City 231, Taiwan (R.O.C.).

is herewith confirmed to comply with the requirements set out in the Council Directive on the Approximation of the Laws of the Member States relating to Electromagnetic Compatibility Directive on (2004/108/EC).

For the evaluation regarding the EMC, the following standards were applied:

EN 55022 (CLASS B: 2006 + A1:2007)	
EN 61000-3-2 (2006 + A2:2009)	
EN 61000-3-3 (2008)	
EN 55024 (1998+A1:2001+A2:2003)	EN 50130-4 (1995+A1:1998+A2:2003)
IEC 61000-4-2 (2008)	EN 61000-4-2 (1995)
IEC 61000-4-3 (2006 + A1:2008 + A2:2010)	EN 61000-4-3 (1996)
IEC 61000-4-4 (2004 + A1:2010)	EN 61000-4-4 (1995)
IEC 61000-4-5 (2005)	EN 61000-4-5 (1995)
IEC 61000-4-6 (2008)	EN 61000-4-6 (1996)
IEC 61000-4-8 (2009)	EN 61000-4-11 (1994)
IEC 61000-4-11 (2004)	

Responsible for marking this declaration if the:

Manufacturer Authorized representative established within the EU

Authorized representative established within the EU (if applicable):

Company Name: Planet Technology Corp.

Company Address: 10F., No.96, Minquan Rd., Xindian Dist., New Taipei City 231, Taiwan (R.O.C.)

Person responsible for making this declaration

Name, Surname Kent Kang

Position / Title : Product Manager

Taiwan
Place

22, Dec., 2011
Date



Legal Signature

PLANET TECHNOLOGY CORPORATION

EC Declaration of Conformity

For the following equipment:

*Type of Product : IEEE 802.3at High Power over Ethernet Injector (25 Watts)
*Model Number : POE-161

* Produced by:

Manufacturer's Name : **Planet Technology Corp.**
Manufacturer's Address : 10F., No.96, Minquan Rd., Xindian Dist.,
New Taipei City 231, Taiwan (R.O.C.).

is herewith confirmed to comply with the requirements set out in the Council Directive on the Approximation of the Laws of the Member States relating to Electromagnetic Compatibility Directive on (2004/108/EC).

For the evaluation regarding the EMC, the following standards were applied:

EN 55022 (CLASS B: 2006 + A1:2007)
EN 61000-3-2 (2006)
EN 61000-3-3 (1995+A1:2001+A2:2005)
EN 55024 (1998+A1:2001+A2:2003) EN 50130-4 (1995+A1:1998+A2:2003)
IEC 61000-4-2 (2008) EN 61000-4-2 (1995)
IEC 61000-4-3 (2008) EN 61000-4-3 (1996)
IEC 61000-4-4 (2004) EN 61000-4-4 (1995)
IEC 61000-4-5 (2005) EN 61000-4-5 (1995)
IEC 61000-4-6 (2008) EN 61000-4-6 (1996)
IEC 61000-4-8 (2009) EN 61000-4-11 (1994)
IEC 61000-4-11 (2004)

Responsible for marking this declaration if the:

Manufacturer Authorized representative established within the EU

Authorized representative established within the EU (if applicable):

Company Name: Planet Technology Corp.

Company Address: 10F., No.96, Minquan Rd., Xindian Dist., New Taipei City 231, Taiwan (R.O.C.)

Person responsible for making this declaration

Name, Surname Kent Kang

Position / Title : Product Manager

Taiwan
Place

27, Aug., 2010
Date



Legal Signature

PLANET TECHNOLOGY CORPORATION

e-mail: sales@planet.com.tw http://www.planet.com.tw

10F., No.96, Minquan Rd., Xindian Dist., New Taipei City, Taiwan, R.O.C. Tel:886-2-2219-9518 Fax:886-2-2219-9528

