



OUTDOOR INSTALLATION WARNING

IMPORTANT SAFETY PRECAUTIONS:

LIVES MAY BE AT RISK! Carefully observe these instructions and any special instructions that are included with the equipment you are installing.

IMPORTANT: Look over the site before beginning any installation, and anticipate possible hazards, especially these:

CONTACTING POWER LINES CAN BE LETHAL. Make sure no power lines are anywhere where possible contact can be made. Antennas, masts, towers, guy wires or cables may lean or fall and contact these lines. People may be injured or killed if they are touching or holding any part of equipment when it contacts electric lines. Make sure there is NO possibility that equipment or personnel can come in contact directly or indirectly with power lines.

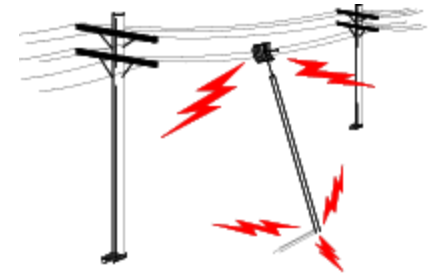

Assume all overhead lines are power lines.

The horizontal distance from a tower, mast or antenna to the nearest power line should be at least twice the total length of the mast/antenna combination. This will ensure that the mast will not contact power if it falls either during installation or later.

TO AVOID FALLING, USE SAFE PROCEDURES WHEN WORKING AT HEIGHTS ABOVE GROUND.

- Select equipment locations that will allow safe, simple equipment installation.
- Don't work alone. A friend or co-worker can save your life if an accident happens.
- Use approved non-conducting ladders and other safety equipment. Make sure all equipment is in good repair.
- If a tower or mast begins falling, don't attempt to catch it. Stand back and let it fall.
- If anything such as a wire or mast does come in contact with a power line, **DON'T TOUCH IT OR ATTEMPT TO MOVE IT.** Instead, save your life by calling the power company.
- Don't attempt to erect antennas or towers on windy days.

MAKE SURE ALL TOWERS AND MASTS ARE SECURELY GROUNDED, AND ELECTRICAL CABLES CONNECTED TO ANTENNAS HAVE LIGHTNING ARRESTORS. This will help prevent fire damage or human injury in case of lightning, static build-up, or short circuit within equipment connected to the antenna.

- The base of the antenna mast or tower must be connected directly to the building protective ground or to one or more approved grounding rods, using 1 OAWG ground wire and corrosion-resistant connectors.
- Refer to the National Electrical Code for grounding details.
- Lightning arrestors for antenna feed coaxial cables are available from HyperLink Technologies, Inc.

IF A PERSON COMES IN CONTACT WITH ELECTRICAL POWER, AND CANNOT MOVE:

- **DON'T TOUCH THAT PERSON, OR YOU MAY BE ELECTROCUTED.**
- Use a non-conductive dry board, stick or rope to push or drag them so they no longer are in contact with electrical power.
- Once they are no longer contacting electrical power, administer CPR if you are certified, and make sure that emergency medical aid has been requested.

MOUNTING INSTRUCTIONS

Models: RE08P, HG2408P

Vertical Polarized Mounting

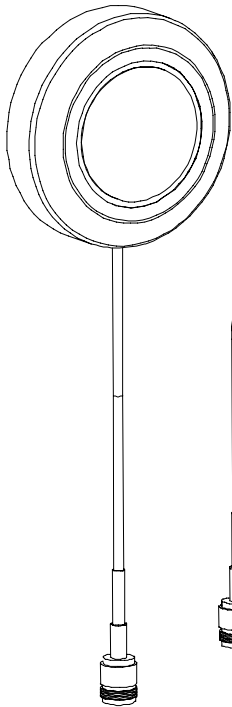

Horizontal Polarized Mounting

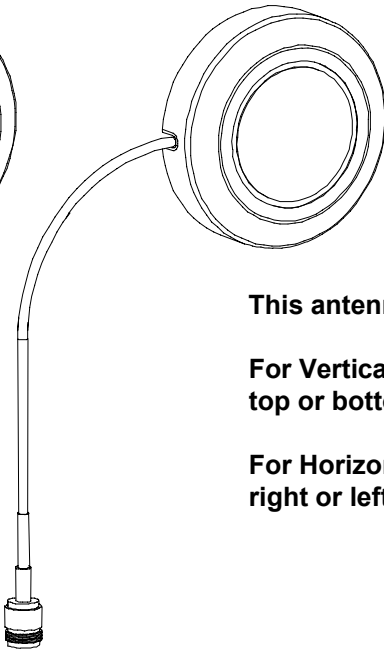

This antenna can be mounted flat against the wall. Its unique design allows the cable to exit out of the side or from the back of the unit, which is ideal for locations that require the cable to be hidden. It will also accept most tilt-and-swivel security camera brackets equipped with standard 1/4-20 threads. (See Optional Mounting Kits)

This antenna can be mounted for Vertical or Horizontal polarization.

For Vertical Polarization, the cable should be exiting from either the top or bottom of antenna.

For Horizontal Polarization, the cable should be exiting from either right or left side of the antenna.

INSTALLATION TEMPLATE

(For Flat Mounting)

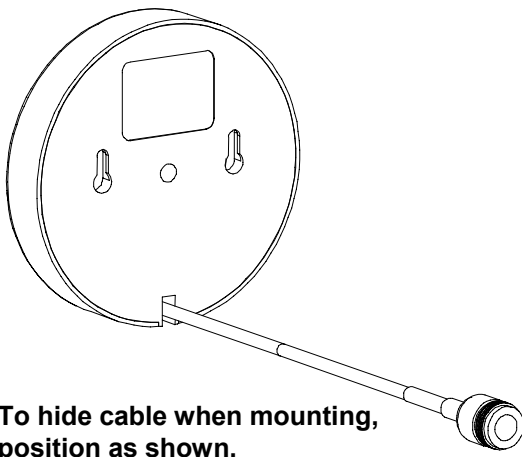

To hide cable when mounting, position as shown.

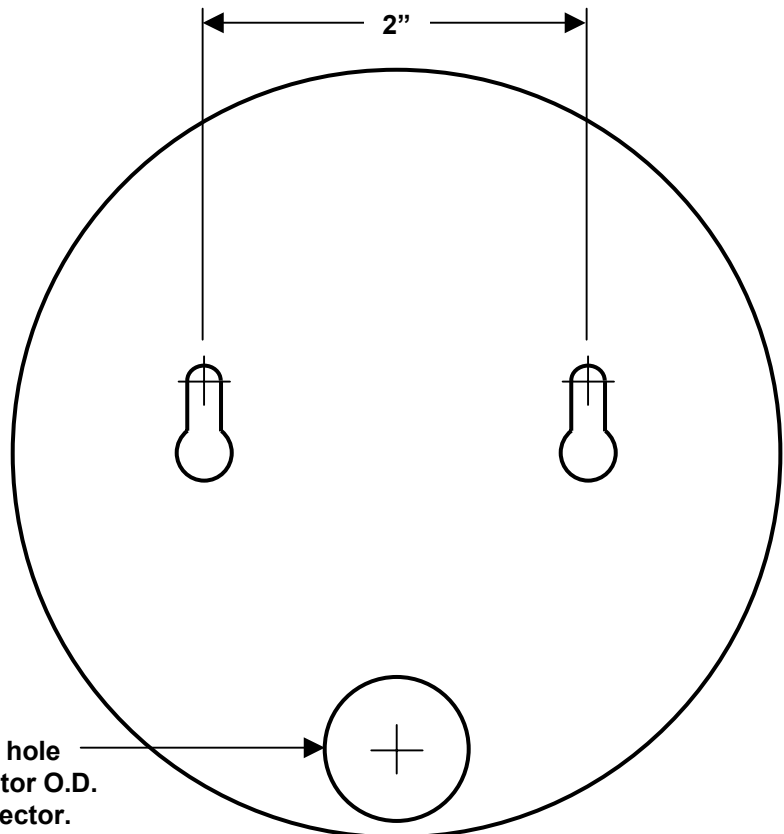

Drill one clearance hole larger than connector O.D. for cable and connector.

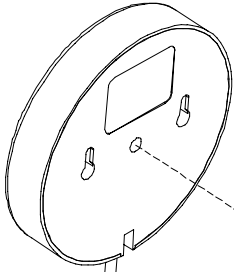

**HGX-PMT02 - Small Metal
Tilt-and-Swivel Wall
Mounting Bracket**

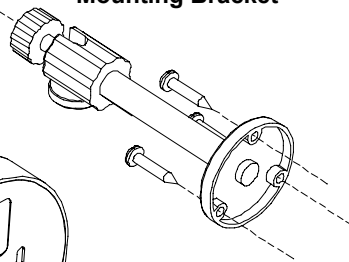

OPTIONAL MOUNTING KITS

(Sold Separately)

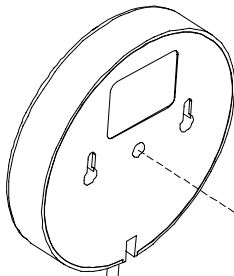

**HGX-PMT03 - Medium Plastic
Tilt-and-Swivel Wall/Desktop
Mounting Bracket**

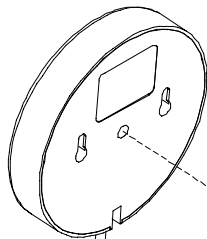
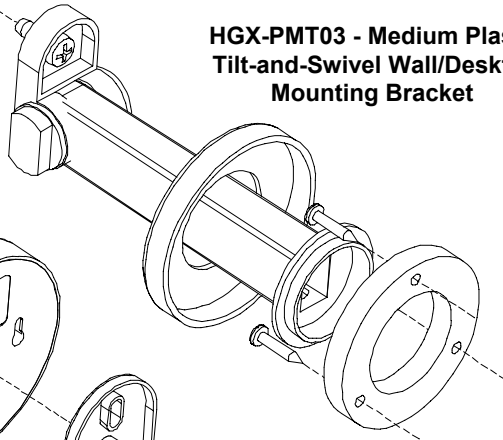

**HGX-PMT04 - Large Metal
Tilt-and-Swivel Mounting
Bracket for Wall or Mast
mounting**

