

# DC SHUNT CURRENT SENSOR & OVER-CURRENT PROTECTOR

## User Guide for SRCN-C412-1

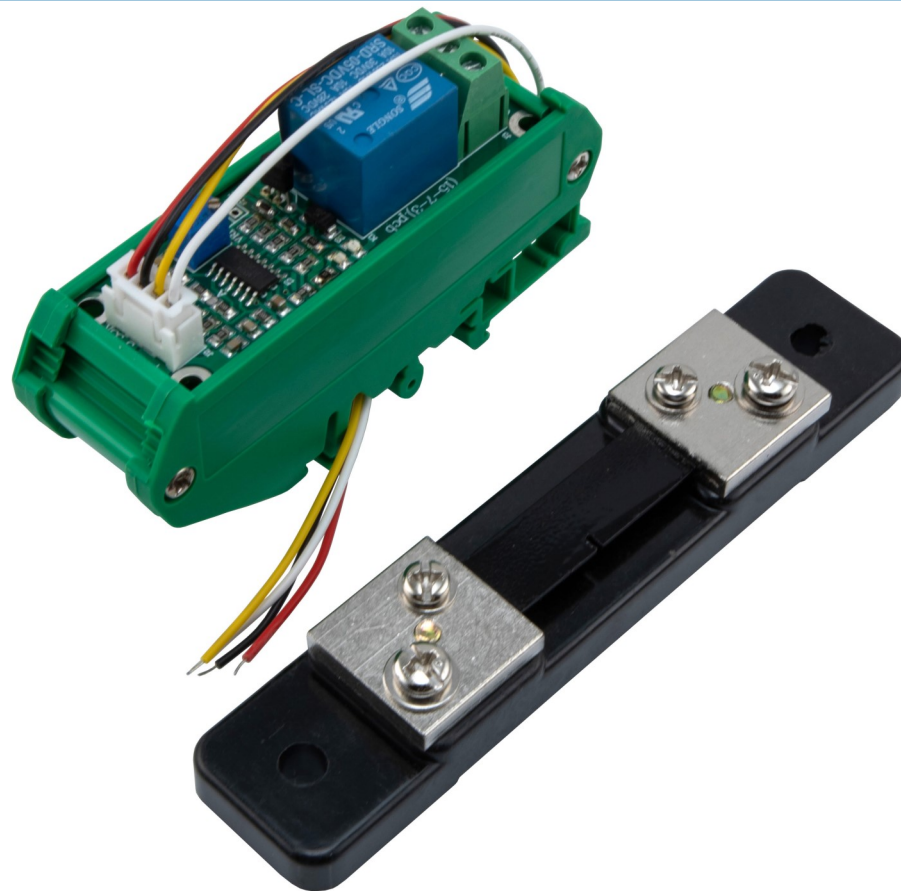

### **Product Description** >>

This module is used to measure and monitor current consumption by utilizing an external shunt resistor. If the current exceeds a preset value, the relay on the module is activated. Uses include building automation and facility management systems where acquiring information on energy usage can lead to increased efficiency. They can also detect equipment issues and help prevent damage by detecting over-current and/or short-circuit conditions.

### **Features** >>

- Low power consumption
- External shunt resistor
- Relay output
- 35 mm DIN rail or panel mountable
- Includes 8in cable

### **Applications** >>

- Building and facilities management
- HVAC
- Battery management system
- Electric fans
- Electric pumps
- Devices requiring over-current & short-circuit protection

Thank you for choosing L-com product. To ensure safe, accurate performance and product longevity, please take a moment to familiarize yourself with this manual before powering the device. Please keep it handy for future reference. In case of any questions regarding the installation or use of product, please call us at 800.341.5266.

Reach out to us at [customerservice@l-com.com](mailto:customerservice@l-com.com) and visit our website at [www.l-com.com](http://www.l-com.com)

## Technical Parameters >>

Working voltage		5 VDC $\pm$ 0.5 VDC
Working current		$\leq$ 120 mA
Detection range		0 – 50 A
Relay response time		300 – 500 ms
Output mode		Relay output
Working environment	Temperature	0 – 65 °C
	Humidity	0 – 95% RH
Installation mode	Pedestal	Mounting on 35mm DIN rail
	Module	Mounting with screws

## Electrical Diagram >>

Note: On the PCBA, CK is the (NO) normally open terminal, COM is the open terminal, CB is the (NC) normally closed terminal.

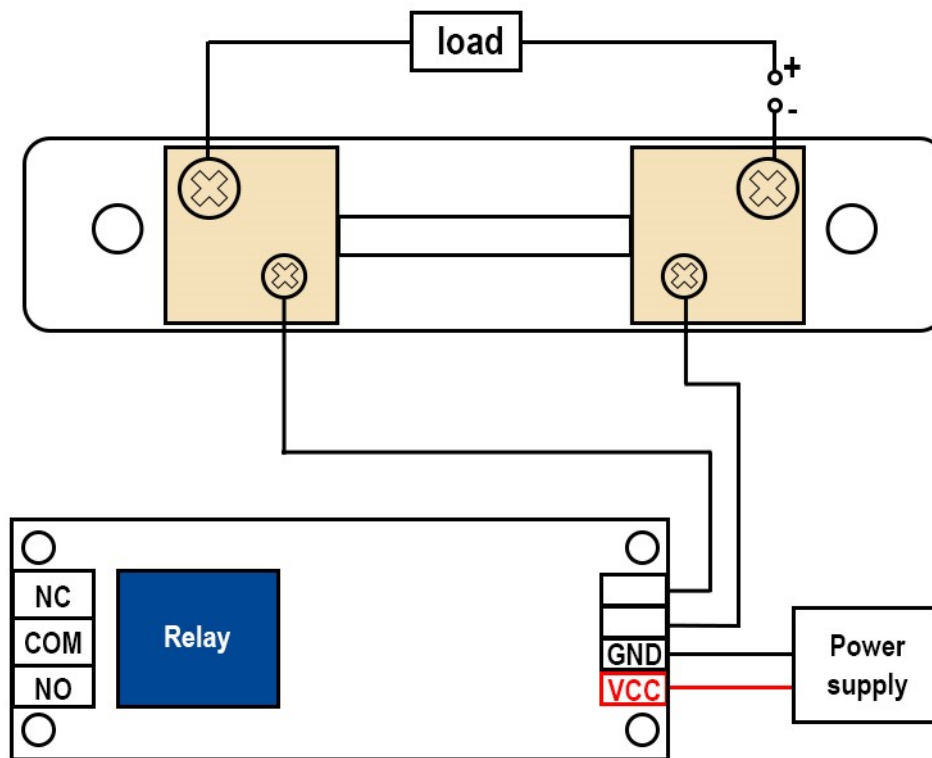

## Mounting Diagram >>

35mm DIN rail mounting: Mount the sensor module onto the DIN rail (dark black) as shown in the figure.

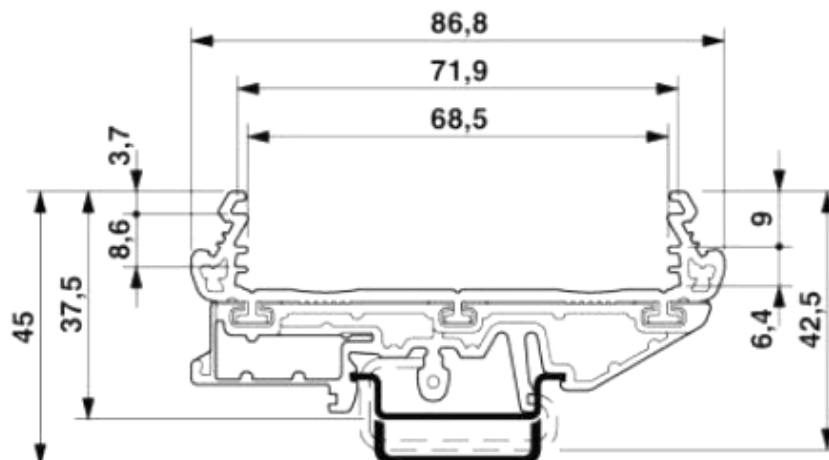

## Board Mount >>

Mount the PCB to the enclosure with screws. Mounting hole diameter is 3mm.

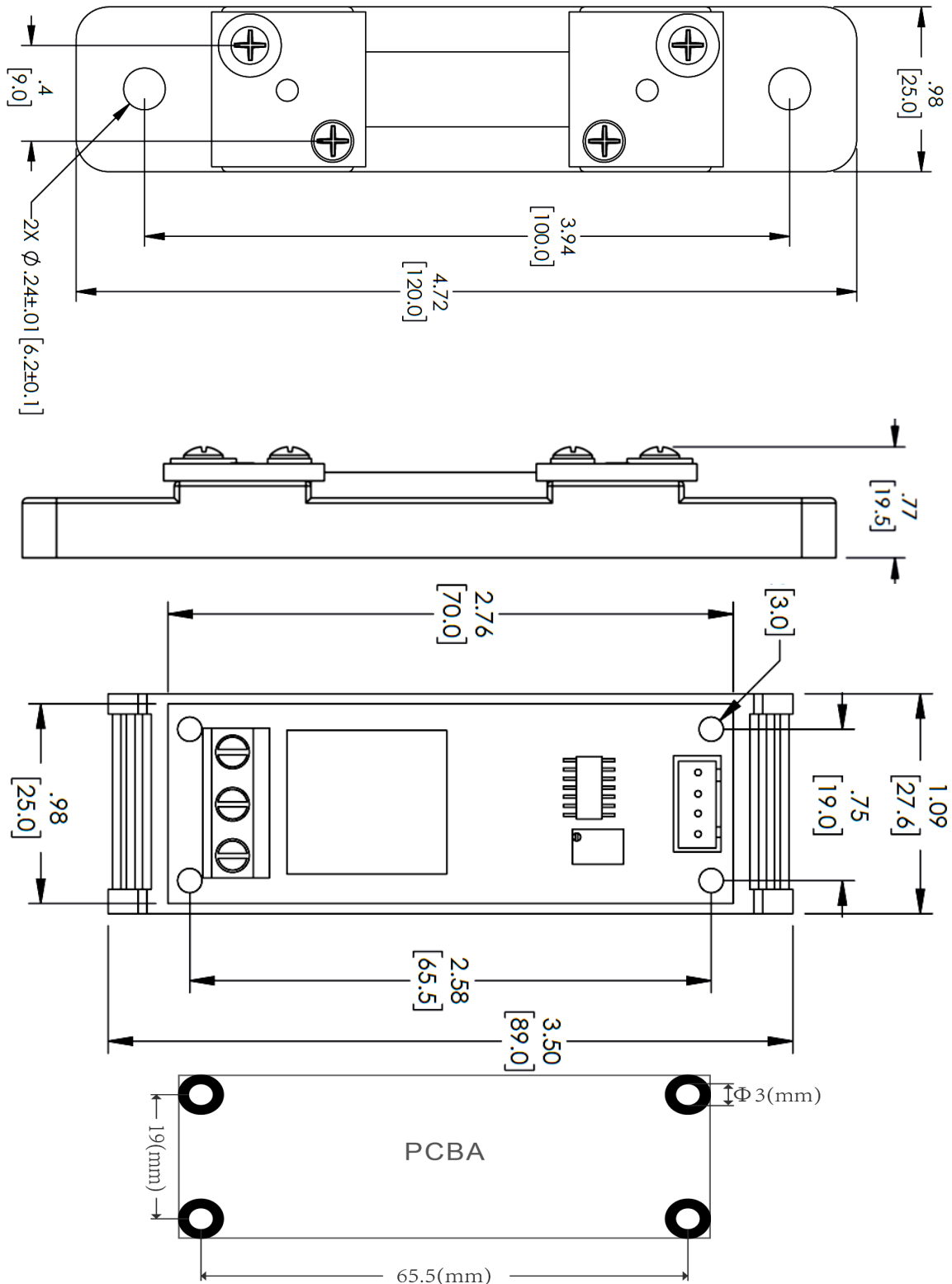

## Notes >>

1. The module can only be powered by 5VDC.
2. Make sure the shunt is connected in series with the negative pole of the detection loop in order to read the signal normally.
3. Pay attention to the direction when connecting the signal terminal. The negative end of the load is the signal positive, and the negative end of the power supply has the signal ground.
4. VR1 is a potentiometer for adjusting the threshold. The threshold voltage can be measured at point A to determine the value.
5. Due to the detection error of the shunt itself and the temperature drift of the op amp, there may be errors in the detection process. The module power supply circuit and the current circuit under test should preferably be independent of each other, so as to avoid damage to the device caused by interference and wiring errors.