

# Description and operating instructions Industrial Rail Switch

## SPIDER 5TX

Order No.

**943 824-001**

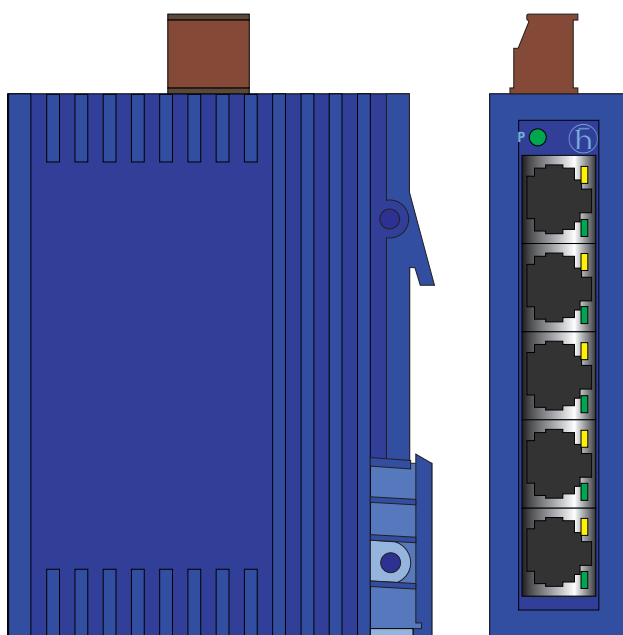

The Rail Switch SPIDER 5TX has been especially designed for use in industrial environments. It supports ETHERNET 10 MBit/s and Fast ETHERNET 100 MBit/s.

The devices support switched ETHERNET networks in accordance with IEEE standard 802.3 or 802.3u using copper technology. The devices are plugged onto the standard bar.

The devices have five 10/100 MBit/s twisted pair ports (RJ45 connectors).

It is possible to connect up to five data terminal equipments or other network segments to the 10/100 Mbit/s ports using twisted pair cabling. The ports support autonegotiation, autopolarity and autocrossing.

The performance features described here are binding only if they have been expressly guaranteed in the contract. We have checked that the contents of the technical publication agree with the hardware and software described. However, it is not possible to rule out deviations completely, so we are unable to guarantee complete agreement. However, the details in the technical publication are checked regularly. Any corrections which prove necessary are contained in subsequent editions. We are grateful for suggestions for improvement.

We reserve the right to make technical modifications.

Permission is not given for the circulation or reproduction of this document, its use or the passing on of its contents unless granted expressly. Contravention renders the perpetrator liable for compensation for damages. All rights reserved, in particular in the case of patent grant or registration of a utility or design.

Copyright  
© Hirschmann Electronics GmbH & Co. KG 2003  
All Rights Reserved

## Note

We would point out that the content of these operating instructions is not part of, nor is it intended to amend an earlier or existing agreement, permit or legal relationship. All obligations on Hirschmann arise from the respective purchasing agreement which also contains the full warranty conditions which have sole applicability. These contractual warranty conditions are neither extended nor restricted by comments in these operating instructions.

We would furthermore point out that for reasons of simplicity, these operating instructions cannot describe every conceivable problem associated with the use of this equipment. Should you require further information or should particular problems occur which are not treated in sufficient detail in the operating instructions, you can request the necessary information from your local Hirschmann sales partner or directly from the Hirschmann office (address: refer to chapter entitled „Notes on CE identification“).

## Safety Instructions

This manual contains instructions which must be observed to ensure your own personal safety and to avoid damage to devices and machinery. The instructions are highlighted with a warning triangle and are shown as follows according to the degree of endangerment:

 **Danger!** means that death, serious injury or considerable damage to property **will** result if the appropriate safety measures are not taken.

 **Warning!** means that death, serious injury or considerable damage to property **can** result if the appropriate safety measures are not taken.

 **Caution!** means that light injury or damage to property can result if the appropriate safety measures are not taken.

**Note:** is an important piece of information about the product, how to use the product, or the relevant section of the documentation to which particular attention is to be drawn.

## Certified usage

Please observe the following:

 **Warning**  
The device may only be employed for the purposes described in the catalog and technical description, and only in conjunction with external devices and components recommended or approved by Hirschmann. The product can only be operated correctly and safely if it is transported, stored, installed and assembled properly and correctly. Furthermore, it must be operated and serviced carefully.

## Safety Guidelines Power Supply

Switch the basic devices on only when the case is closed.

 **Warning!**  
The devices may only be connected to the supply voltage shown on the type plate.

The devices are designed for operation with a safety extra-low voltage. Thus, they may only be connected to the supply voltage connections with PELV circuits or alternatively SELV circuits with the voltage restrictions in accordance with IEC/EN 60950.

For the case where the module is operated with external power supply: Use only a safety extra-low voltage in accordance with IEC 950/EN 60 950/VDE 0805 to power the system.

First of all you connect the protecting line, before you establish the further connections. When you remove connections, you disconnect the protecting line last.

Relevant for North America:  
The subject unit is to be supplied by a Class 2 power source complying with the requirements of the National Electrical Code, table 11(b). If power is redundant supplied (two individual power sources) the power sources together should comply with the requirements of the National Electrical Code, table 11 (b).

Relevant for North America:  
Use 60/75°C or 75°C copper(CU)wire only.

## Safety Guidelines Shielding Ground

Beware of possible short circuits when connecting a cable section with conductive shielding braiding.

## Safety Guidelines Housing

 **Warning!**  
Only technicians authorized by Hirschmann are permitted to open the housing.

**Note:** The SPIDER 5TX is grounded via a pin of the 3pin terminal block.

Make sure that the electrical installation meets local or nationally applicable safety regulations.

 **Warning!**  
The ventilation slits must not be covered so as to ensure free air circulation.  
The distance to the ventilation slots of the housing has to be a minimum of 10 cm.

Never insert pointed objects (thin screwdrivers, wires, etc.) into the inside of the subrack! Failure to observe this point may result in injuries caused by electric shocks.

**Note:** In accordance with EN 60950, when installed in residential or business premises the device may only be operated in fire-proof cabinets.

**Note:** The housing has to be mounted in upright position.

## Safety Guidelines Environment

 **Warning!**  
The device may only be operated in the listed ambient temperature range at the listed relative air humidity (non-condensing).

The installation location is to be selected so as to ensure compliance with the climatic limits listed in the Technical Data.

To be used in a Pollution Degree 2 environment only.

## Staff qualification requirements

**Note:** Qualified personnel, as understood in this manual and in the warning signs, are persons who are familiar with the setup, assembly, startup, and operation of this product and are appropriately qualified for their job. This includes, for example, those persons who have been:

– trained or directed or authorized to switch on and off, to ground and to label power circuits and devices or systems in accordance with current safety engineering standards

- trained or directed in the care and use of appropriate safety equipment in accordance with the current standards of safety engineering
- trained in providing first aid.

### General Safety Instructions

This device is electrically operated. Adhere strictly to the safety requirements relating to voltages applied to the device as described in the operating instructions!

**Warning!**  
Failure to observe the information given in the warnings could result in serious injury and/or major damage.

Only personnel that have received appropriate training should operate this device or work in its immediate vicinity. The personnel must be fully familiar with all of the warnings and maintenance measures in these operating instructions.

Correct transport, storage, and assembly as well as careful operation and maintenance are essential in ensuring safe and reliable operation of this device.

Use only undamaged parts!

- These products are only to be used in the manner indicated in this version of the "Description and Operating Instructions".
- Particular attention is to be paid to all warnings and items of information relating to safety.

**Warning!**  
Any work that may have to be performed on the electrical installation should be performed by fully qualified technicians only.

### Based specifications and standards:

The devices fulfil the following specifications and standards:

- EN 61000-6-2:2001 Generic standards – Immunity for industrial environments
- EN 55022:1998 + A1 2000 – Information technology equipment – Radio disturbance characteristics
- EN 60950:1997 – Safety of Information Technology Equipment (ITE)
- EN 61131-2:1994 + A12 2000 – Programmable Controllers
- FCC 47 CFR Part 15:2000 – Code of Federal Regulations
- cUL 508:1998 – Underwriters Laboratories Inc. Safety for Industrial Control Equipment.

Certified devices are marked with a certification identifier.

### CE Notes on CE identification

The devices comply with the regulations of the following European directive:

89/336/EEC

Council Directive on the harmonization of the legal regulations of member states on electromagnetic compatibility (amended by Directives 91/263/EEC, 92/31/EEC and 93/68/EEC).

The EU declaration of conformity is kept available for the responsible authorities in accordance with the above-mentioned EU directives at:

Hirschmann Electronics GmbH & Co. KG  
Automation and Network Solutions  
Stuttgarter Straße 45-51  
D-72654 Neckartenzlingen  
Telephone ++49-7127-14-1480

The product can be used in the residential sphere (residential sphere, business and trade sphere and small companies) and in the industrial sphere.

- Interference immunity: EN 61000-6-2:2001
- Radio interference level: EN 55022:1998 + A1 2000 Class A

**Warning!**  
This is a Class A device. This equipment may cause radio interference if used in a residential area; in this case it is the operator's responsibility to take appropriate measures.

The precondition for compliance with EMC limit values is strict adherence to the construction guidelines specified in this description and operating instructions.

### FCC Note:

This equipment has been tested and found to comply with the limits for a Class A digital device, pursuant to part 15 of the FCC Rules. These limits are designed to provide reasonable protection against harmful interference when the equipment is operated in a commercial environment. This equipment generates, uses, and can radiate radio frequency energy and, if not installed and used in accordance with the instruction manual, may cause harmful interference to radio communications. Operation of this equipment in a residential area is likely to cause harmful interference in which case the user will be required to correct the interference at his own expense.



### Recycling Note:

After its use, this product has to be processed as electronic scrap and disposed of according to the prevailing waste disposal regulations of your community / district / country / state.

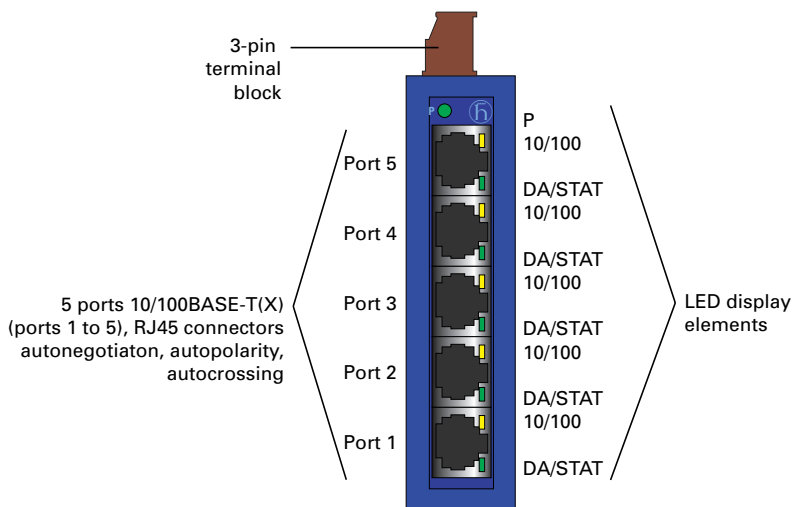

Fig. 1: Overview interfaces, display elements and controls

## 1. Functional description

The 10/100BASE-T(X) ports of an SPIDER 5TX represent a terminal connection for the connected LAN segment. You can connect single devices or complete network segments.

### 1.1 FRAME SWITCHING FUNCTIONS

#### Store and Forward

All data received by the SPIDER 5TX from the system bus or at the ports are stored and checked for validity. Invalid and defective frames (> 1.522 byte or CRC error) as well as fragments (< 64 byte) are discarded. The SPIDER 5TX forwards the valid frames.

#### Multi address capability

An SPIDER 5TX learns all source addresses per port. Only packets with

- unknown addresses
- addresses learnt at this port
- a multi/broadcast address

in the destination address field are sent to this port.

An SPIDER 5TX learns up to 1,000 addresses. This becomes necessary if more than one terminal device is connected to one or more ports. In this way several independent subnetworks can be connected to an SPIDER 5TX.

#### Learnt addresses

An SPIDER 5TX monitors the age of the learned addresses. The SPIDER 5TX deletes address entries from the address table which exceed a certain age (300 seconds).

**Note:** Restarting deletes the learned address entries.

#### Tagging (IEEE 802.1Q)

The IEEE 802.1 Q standard designates the VLAN tag to be included in a MAC data frame for the VLAN and prioritizing functions. The VLAN tag consists of 4 bytes (2 bytes tag protocol identifier TPID, 2 bytes tag control information TCI). It is inserted between the source address field and the type field. Data packets with VLAN tag are transmitted unchanged by the SPIDER 5TX.

### 1.2 SPECIFIC FUNCTIONS OF THE TP/TX INTERFACE

#### Link control

The SPIDER 5TX monitors the connected TP line segments for short-circuit or interrupt using regular link test pulses in accordance with IEEE standard 802.3 10BASE-T/-100BASE-TX. The SPIDER 5TX does not transmit any data to a TP segment from which it does not receive a link test pulse.

**Note:** A non-occupied interface is assessed as a line interrupt. The TP line to terminal equipment which is switched off is likewise assessed as a line interrupt as the de-energised bus coupler cannot transmit link test pulses.

#### Auto polarity exchange

If the receive line pair is incorrectly connected (RD+ and RD- switched) polarity is automatically reversed.

#### Autonegotiation

Autonegotiation is a procedure in which the switch automatically selects the operating mode of its 10/100 RJ-45 ports. When a connection is set up for the first time, the switch detects the speed (10 or 100 Mbit/s) and the transmission mode of the connected network (half duplex or full duplex).

#### Autocrossing

The SPIDER 5TX detects the transmit and receive pairs (MDI, MDI-X). The SPIDER 5TX automatically configures its port for the correct transmit and receive pins. Consequently it does not matter whether you connect devices using a cross-over or straight cable.

### 1.3 FURTHER FUNCTIONS AND FEATURES

#### Reset

The SPIDER 5TX will be reset by the following action:

- input voltages fall below a threshold

After a reset the following action is carried through:

- initialization

### 1.4 DISPLAY ELEMENTS

#### Equipment status

These LEDs provide information about statuses which affect the function of the entire SPIDER 5TX.

#### P – Power (green LED)

- lit: - supply voltage present

#### Port Status

These LEDs display port-related information.

#### DA/STAT 1 to 5 – Data, Link status (green LED)

- not lit: - no valid link
- lit green: - valid link
- flashes green: - receiving data

#### 10/100 1 bis 5 – Data rate (yellow LED)

- leuchtet nicht: 10 Mbit/s link
- leuchtet yellow: 100 Mbit/s link

### 1.5 INTERFACES

#### 10/100 MBit/s connection

Five 10/100 Mbit/s Ports (ports 1 to port 5, 8-pin R45 sockets) on SPIDER 5TX allow terminal equipment or five independent network segments complying with the standards IEEE 802.3 100BASE-TX / 10BASE-T to be connected. These ports support autonegotiation and the autopolarity function.

The pin configuration complies with MDI-X.

#### - Pin configuration of the RJ45 socket:

- 1 line pair: pin 3 and pin 6
- 1 line pair: pin 1 and pin 2
- remaining pins: not used.

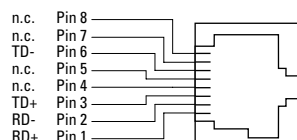

Fig. 2: Pin configuration of an TP interface

### 3pin terminal block

The supply voltage is connected via a 3pin terminal block.



#### Warning!

The SPIDER 5TX devices are designed for operation with a safety extra-low voltage. Thus, they may only be connected to the supply voltage connections with PELV circuits or alternatively SELV circuits with the voltage restrictions in accordance with IEC/EN 60950.

- **Voltage supply:** The supply voltage is electrically isolated from the housing.

- **Ground connection:** The SPIDER 5TX is grounded via a pin of the 3pin terminal block.

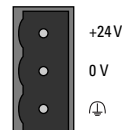

Fig. 3: Pin configuration of 3pin terminal block

## 2. Configuration

### 2.1 CONNECTING DTE AND OTHER NETWORK SEGMENTS

It is possible to connect up to five data terminal equipments (DTE) or other network segments to the 10/100 Mbit/s ports of the SPIDER 5TX using twisted pair cabling (ref. Fig. 4).

## 3. Assembly, startup procedure and dismantling

### 3.1 UNPACKING, CHECKING

- Check whether the package was delivered complete (see scope of delivery).
- Check the individual parts for transport damage.



#### Warning!

Use only undamaged parts!

### 3.2 ASSEMBLY

The equipment is delivered in a ready-to-operate condition. The following procedure is appropriate for assembly:

- Pull the terminal block off the SPIDER 5TX and wire up the supply voltage lines.
- Fit the SPIDER 5TX on a 35 mm standard bar to DIN EN 50 022.
- Attach the upper snap-on slide bar of the SPIDER 5TX to the standard bar and press it down until it locks in position.
- Fit the signal lines.

#### Notes:

- The SPIDER 5TX is grounded via a pin of the terminal block.

- Do not open the housing.

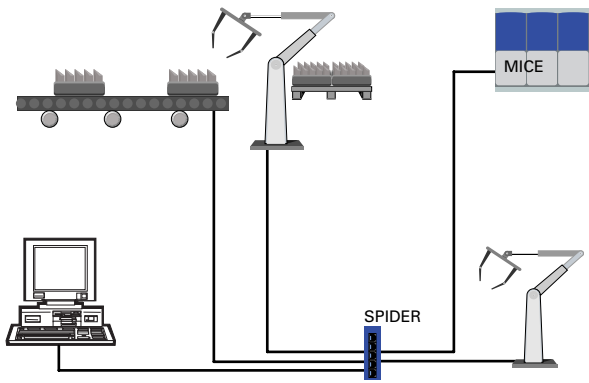

Fig. 4: Configuration with SPIDER 5TX: Connection of up to 8 data terminal equipments or further segments via TP

– The shielding ground of the twisted pair lines which can be connected is electrical-ly connected to the ground connection.

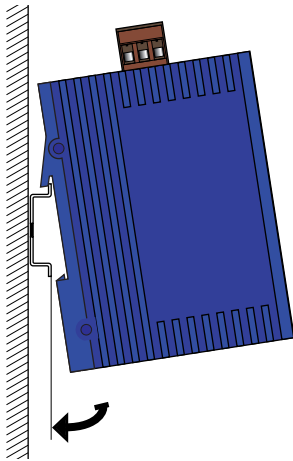

Fig. 5: Assembling the SPIDER 5TX

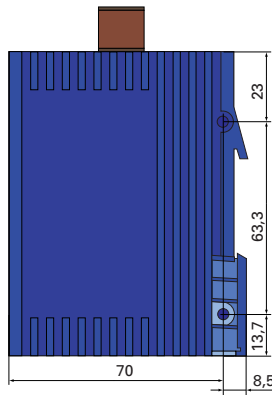

Fig. 6: Dimensions

### 3.3 STARTUP PROCEDURE

□ You start up the SPIDER 5TX by connecting the supply voltage via the 3-pin terminal block.

### 3.4 DISMANTLING

□ To take the SPIDER 5TX off the ISO/DIN rail, unlock the snap-in mechanism according to Fig 7.

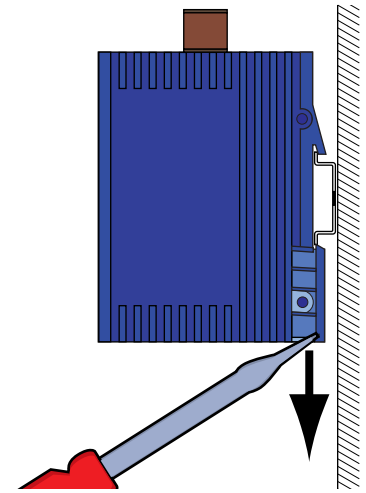

Fig. 7: Dismantling the SPIDER 5TX

## 4. Further support

In the event of technical queries, please talk to the Hirschmann contract partner responsible for looking after your account or directly to the Hirschmann office. You can find the addresses of our contract partners – on the Internet (<http://www.hirschmann.de>).

Our support line is also at your disposal:  
Tel. +49(1805) 14-1538  
Fax +49(7127) 14-1551

Answers to Frequently Asked Questions can be found on the Hirschmann internet site [www.hirschmann.de](http://www.hirschmann.de)  
The FAQs are located under „Service“ in the Automation and Network Solutions section.  
[www.hicomcenter.com](http://www.hicomcenter.com) gives you an up-to-date overview of training courses about technology and products.

## 5. Technical data

### General data

Operating voltage	NEC Class 2 power source 24 VDC (-25% +33%) safety extra-low voltage (SELV/PELV) 5 A maximum	
Buffer time	min. 10 ms at 24 VDC	
Potential difference between input voltage and housing	Potential difference to input voltage, +24 VDC: 32 VDC Potential difference to input voltage, ground: -32 VDC	
Current consumption at 24 VDC	2.9 W maximum	
Overload current protection at input	non-changeable fuse	
Dimensions W x H x D	25 mm x 100 mm x 78.5 mm	1 in x 4 in x 3.1 in
Weight	110 g	0.24 lb
Ambient temperature	0 °C to + 60 °C	32 °F to 140 °F
Storage temperature	- 40 °C to + 70 °C	-32 °F to 158 °F
Humidity	up to 95% (non condensing)	
Atmospheric pressure	min. 79 kPa	
Pollution Degree	2	
Protection type	IP 30	

<b>Interference proof</b>		
Discharge of static electricity		
Contact discharge		EN 61000-4-2 Test level 2
Air discharge		EN 61000-4-2 Test level 3
Electromagnetic fields		EN 61000-4-3 Test level 3
Fast transients		EN 61000-4-4 Test level 3
Surge voltage symmetrical		EN 61000-4-5 Test level 2
Surge voltage asymmetrical		EN 61000-4-5 Test level 3
Cable-based RF faults		EN 61000-4-6 Test level 3

<b>EMC emitted immunity</b>		
EN 55022		Class A
FCC 47 CFR Part 15		Class A

<b>Stability</b>		
Vibration		IEC 60068-2-6 Test FC, testing level in line with IEC 61131-2 E2 CDV and
Shock		IEC 60068-2-27 Test Ea, testing level in line with IEC 61131-2 E2 CDV

<b>Certifications</b>		
cUL 508 / CSA 22.2 No.142		pending

### Network size

#### TP port 10BASE-T/100BASE-TX

Length of a twisted pair segment		100 m (328 ft) maximum
----------------------------------	--	------------------------

### Interfaces

5 TP ports		RJ45 sockets, 10/100 MBit/s
------------	--	-----------------------------

### Displays

Equipment status	1 x green LED	<b>P</b> – power, supply voltage present
Port status	5 x green LEDs	<b>DAT/STAT</b> – data, link status
	5 x yellow LEDs	<b>10/100</b> – Data rate

### Scope of delivery

Rail Switch SPIDER 5TX incl.		terminal block for supply voltage description and operating instructions
------------------------------	--	---

Order number		
Rail Switch SPIDER 5TX		943 824-001

### Accessories

ETHERNET manual		943 320-011
Manual		
Basics  ETHERNET and TCP/IP		280 720-834
Rail Power Supply RPS 30		943 662-003
Rail Power Supply RPS 60		943 662-001
Rail Power Supply RPS 120		943 662-011

Hirschmann Electronics GmbH & Co. KG  
Automation and Network Solutions  
Stuttgarter Straße 45-51  
D-72654 Neckartenzlingen  
Germany  
Tel.: ++49 / 1805 / 14-1538  
Fax: ++49 / 7127 / 14-1551  
E-Mail: ans-support@nt.hirschmann.de  
Internet: <http://www.hirschmann.com>



039669001010703000